

---

User's Guide

---

HP 86120B Multi-Wavelength Meter



HP Part No. 86120-90013  
Printed in USA  
November 1996

First Edition

© Copyright Hewlett-Packard Company 1996  
All Rights Reserved. Reproduction, adaptation, or translation without prior written permission is prohibited, except as allowed under copyright laws.

Hewlett-Packard Company  
Lightwave Operations  
1400 Fountaingrove Parkway  
Santa Rosa, CA 95403-1799, USA  
(707) 577-1400

**Notice.** The information contained in this document is subject to change without notice. Companies, names, and data used in examples herein are fictitious unless otherwise noted. Hewlett-Packard makes no warranty of any kind with regard to this material, including but not limited to, the implied warranties of merchantability and fitness for a particular purpose. Hewlett-Packard shall not be liable for errors contained herein or for incidental or consequential damages in connection with the furnishing, performance, or use of this material.

**Restricted Rights Legend.** Use, duplication, or disclosure by the U.S. Government is subject to restrictions as set forth in subparagraph (c) (1) (ii) of the Rights in Technical Data and Computer Software clause at DFARS 252.227-7013 for DOD agencies, and subparagraphs (c) (1) and (c) (2) of the Commercial Computer Software Restricted Rights clause at FAR 52.227-19 for other agencies.

## Safety Symbols

The following safety symbols are used throughout this manual. Familiarize yourself with each of the symbols and its meaning before operating this instrument.

---

### CAUTION

---







The *caution* sign denotes a hazard to the instrument. It calls attention to a procedure which, if not correctly performed or adhered to, could result in damage to or destruction of the instrument. Do not proceed beyond a caution sign until the indicated conditions are fully understood and met.

---

### WARNING

---

The *warning* sign denotes a life-threatening hazard. It calls attention to a procedure which, if not correctly performed or adhered to, could result in injury or loss of life. Do not proceed beyond a warning sign until the indicated conditions are fully understood and met.

	The instruction manual symbol. The product is marked with this warning symbol when it is necessary for the user to refer to the instructions in the manual.
	The laser radiation symbol. This warning symbol is marked on products which have a laser output.
	This symbol denotes that the instrument uses alternating current.
	These symbols denotes that the power supply is turned on.
	These symbols denotes that the power supply is turned off.
	The CE mark is a registered trademark of the European Community.
ISM1-A	This text denotes that the instrument is an Industrial Scientific and Medical Group 1 Class A product.
	The CSA mark is a registered trademark of the Canadian Standards Association.

---

## The HP 86120B—At a Glance

The HP 86120B Multi-Wavelength Meter measures the wavelength and optical power of laser light in the 700-1650 nm wavelength range. Because the HP 86120B simultaneously measures multiple laser lines, you can characterize wavelength-division-multiplexed (WDM) systems and the multiple lines of Fabry-Perot lasers.

### ***Characterize laser lines easily***

With the HP 86120B you can quickly and easily measure any of the following parameters:

- Wavelengths and powers
- Average wavelength
- Total optical power
- Laser line separation
- Laser drift (*wavelength and power*)
- Signal-to-noise ratios (*unmodulated lasers*)
- Coherence length

In addition to these measurements, a “power bar” is displayed that shows power changes like a traditional analog meter. You can see the power bar shown in the following figure of the HP 86120B's display.

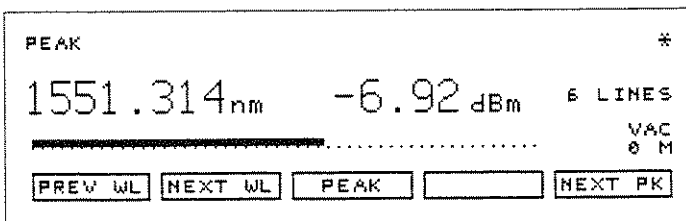

peakw

---

**CAUTION**

---

The input circuitry of the HP 86120B can be damaged when *total* input power levels exceed +18 dBm. To prevent input damage, this specified level must not be exceeded.

***Print measurement results***

You can get hardcopy results of your measurements by connecting a printer to the rear-panel PARALLEL PRINTER PORT connector.

***Program the instrument for automatic measurements***

The HP 86120B offers an extensive set of HP-IB programming commands. These commands allow you to perform automated measurements on manufacturing production lines and remote sites. Chapters 3 and 4 provide all the information you'll need to know in order to program the HP 86120B.

***Display wavelengths as if measured in vacuum or standard air***

Although all measurements are made in air, displayed results are corrected for air dispersion to accurately show wavelength values in vacuum or in "standard air." To ensure accurate wavelength measurements, make sure that you enter the elevation from which you will be making measurements as described in Chapter 1, "Getting Started".

**Measurement accuracy—it's up to you!**

Fiber-optic connectors are easily damaged when connected to dirty or damaged cables and accessories. The HP 86120B's front-panel INPUT connector is no exception. When you use improper cleaning and handling techniques, you risk expensive instrument repairs, damaged cables, and compromised measurements.

Before you connect any fiber-optic cable to the HP 86120B, refer to "Cleaning Connections for Accurate Measurements" on page 2-43.

## General Safety Considerations

---

### General Safety Considerations

This product has been designed and tested in accordance with IEC Publication 1010, Safety Requirements for Electronic Measuring Apparatus, and has been supplied in a safe condition. The instruction documentation contains information and warnings which must be followed by the user to ensure safe operation and to maintain the product in a safe condition.

---

**WARNING**

---

**If this instrument is not used as specified, the protection provided by the equipment could be impaired. This instrument must be used in a normal condition (in which all means for protection are intact) only.**

---

**WARNING**

---

**No operator serviceable parts inside. Refer servicing to qualified personnel. To prevent electrical shock, do not remove covers.**

---

## Printing History

HP Part Number	Edition	Date
86120-90009	First	September 1996

---

## Typographical Conventions

The following conventions are used in this book.

<u>Formatting</u>	<u>Information</u>
key type	Keys or text located on the keyboard or instrument.
<i>softkey</i> type	Key names that are displayed on the instrument's screen.
display type	Words or characters displayed on the computer's screen or instrument's display.
<b>user</b> type	Words or characters that you type or enter.
<i>emphasis</i> type	Words or characters that emphasize some point or that are used as place holders for text that you type.

## Warranty

---

### Warranty

This Hewlett-Packard instrument product is warranted against defects in material and workmanship for a period of one year from date of shipment. During the warranty period, Hewlett-Packard Company will, at its option, either repair or replace products which prove to be defective.

For warranty service or repair, this product must be returned to a service facility designated by Hewlett-Packard. Buyer shall prepay shipping charges to Hewlett-Packard and Hewlett-Packard shall pay shipping charges to return the product to Buyer. However, Buyer shall pay all shipping charges, duties, and taxes for products returned to Hewlett-Packard from another country.

Hewlett-Packard warrants that its software and firmware designated by Hewlett-Packard for use with an instrument will execute its programming instructions when properly installed on that instrument. Hewlett-Packard does not warrant that the operation of the instrument, or software, or firmware will be uninterrupted or error-free.

### **Limitation of Warranty**

The foregoing warranty shall not apply to defects resulting from improper or inadequate maintenance by Buyer, Buyer-supplied software or interfacing, unauthorized modification or misuse, operation outside of the environmental specifications for the product, or improper site preparation or maintenance.

NO OTHER WARRANTY IS EXPRESSED OR IMPLIED. HEWLETT-PACKARD SPECIFICALLY DISCLAIMS THE IMPLIED WARRANTIES OF MERCHANTABILITY AND FITNESS FOR A PARTICULAR PURPOSE.

### **Exclusive Remedies**

THE REMEDIES PROVIDED HEREIN ARE BUYER'S SOLE AND EXCLUSIVE REMEDIES. HEWLETT-PACKARD SHALL NOT BE LIABLE FOR ANY DIRECT, INDIRECT, SPECIAL, INCIDENTAL, OR CONSEQUENTIAL DAMAGES, WHETHER BASED ON CONTRACT, TORT, OR ANY OTHER LEGAL THEORY.



---

Getting Started



## Getting Started

The instructions in this chapter show you how to install your HP 86120B. You should be able to finish these procedures in about ten to twenty minutes. After you've completed this chapter, continue with Chapter 2, "Making Measurements".

Refer to Chapter 6, "Specifications and Regulatory Information" for information on operating conditions such as temperature.

If you should ever need to clean the cabinet, use a damp cloth only.

---

**WARNING**

**This is a Safety Class I product (provided with a protective earthing ground incorporated in the power cord). The mains plug shall only be inserted in a socket outlet provided with a protective earth contact. Any interruption of the protective conductor inside or outside of the instrument is likely to make the instrument dangerous. Intentional interruption is prohibited.**

---

**CAUTION**

This product has autoranging line voltage input. Be sure the supply voltage is within the specified range.

---

**CAUTION**

When installing the product in a cabinet, the convection into and out of the product must not be restricted. The ambient temperature (outside the cabinet) must be less than the maximum operating temperature of the product by 4°C for every 100 watts dissipated in the cabinet. If the total power dissipated in the cabinet is greater than 800 watts, then forced convection must be used.

---

**CAUTION**

This product is designed for use in INSTALLATION CATEGORY II and POLLUTION DEGREE 2, per IEC 1010 and 664 respectively.

**Contents**

Step 1. Inspect the Shipment 1-4  
Step 2. Check the Fuse 1-6  
Step 3. Connect the Line-Power Cable 1-7  
Step 4. Connect a Printer 1-9  
Step 5. Turn on the HP 86120B 1-10  
Step 6. Enter Your Elevation 1-12  
Step 7. Select Medium for Wavelength Values 1-13  
Step 8. Turn Off Wavelength Limiting 1-14  
Returning the Instrument for Service 1-15

**Measurement accuracy—it's up to you!**

Fiber-optic connectors are easily damaged when connected to dirty or damaged cables and accessories. The HP 86120B's front-panel INPUT connector is no exception. When you use improper cleaning and handling techniques, you risk expensive instrument repairs, damaged cables, and compromised measurements.

Before you connect any fiber-optic cable to the HP 86120B, refer to "Cleaning Connections for Accurate Measurements" on page 2-43.

Getting Started

**Step 1. Inspect the Shipment**

---

## Step 1. Inspect the Shipment

1. Verify that all system components ordered have arrived by comparing the shipping forms to the original purchase order. Inspect all shipping containers.

If your shipment is damaged or incomplete, save the packing materials and notify both the shipping carrier and the nearest Hewlett-Packard sales and Service office. HP will arrange for repair or replacement of damaged or incomplete shipments without waiting for a settlement from the transportation company. Notify the HP customer engineer of any problems.

2. Make sure that the serial number and options listed on the instrument's rear-panel label match the serial number and options listed on the shipping document. The following figure is an example of the rear-panel serial number label:

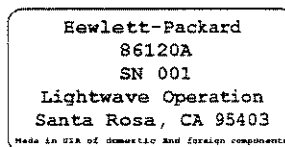

**Table 1-1. Options and Accessories Available for the HP 86120B**

Item	Quantity	HP Part Number
Option 010 Delete FC/PC connector	—	—
Option 011 Diamond HMS-10 connector interface	1	08154-61701
Option 013 DIN 47256 connector interface	1	08154-61703
Option 014 ST connector interface	1	08154-61704
Option 017 SC connector interface	1	08154-61708
Option 022 Replace flat physical contact interface with angled physical contact interface	—	—
Option 900 Great Britain power cord	1	8120-1703
Option 901 Australia, New Zealand, China power cord	1	8120-0696
Option 902 European power cord	1	8120-1692
Option 906 Switzerland power cord	1	8120-2296
Option 912 Denmark power cord	1	8120-2957
Option 917 India, South Africa power cord	1	8120-4600
Option 918 Japanese power cord	1	8120-4754
Option 919 Israel power cord	1	8120-5181
Option UK5 Protective soft carrying case	1	9211-7314
Option UK6 Commercial calibration certificate with calibration data	1	—
Option AXE Rack mount kit with handles	1	86120-60031
Option IX4 Rack mount kit without handles	1	86120-60030
Option OB2 Additional user's manual	1	86120-90001
Option 412 Add 10 dB external attenuator (FC/PC interface connector)	1	1005-0587

---

## Step 2. Check the Fuse

1. Locate the line-input connector on the instrument's rear panel.
2. Disconnect the line-power cable if it is connected.
3. Use a small flat-blade screwdriver to open the pull-out fuse drawer.

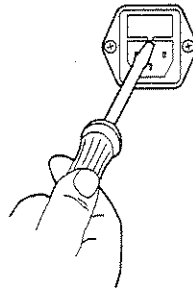

4. Verify that the value of the line-voltage fuse in the pull-out drawer is correct. The recommended fuse is an IEC 127 5×20 mm, 6.3A, 250 V, HP part number 2110-0703.

Notice that an extra fuse is provided in a drawer located on the fuse holder.

---

**WARNING**

**For continued protection against fire hazard, replace line fuse only with same type and ratings, (type T 6.3A/250V for 100/240V operation). The use of other fuses or materials is prohibited.**

---

## Step 3. Connect the Line-Power Cable

---

### WARNING

**This is a Safety Class 1 Product (provided with a protective earthing ground incorporated in the power cord). The mains plug shall only be inserted in a socket outlet provided with a protective earth contact. Any interruption of the protective conductor inside or outside of the instrument is likely to make the instrument dangerous. Intentional interruption is prohibited.**

---

### CAUTION

Always use the three-prong AC power cord supplied with this instrument. Failure to ensure adequate earth grounding by not using this cord may cause instrument damage.

---

### CAUTION

*Do not* connect ac power until you have verified the line voltage is correct as described in the following paragraphs. Damage to the equipment could result.

---

### CAUTION

This instrument has autoranging line voltage input. Be sure the supply voltage is within the specified range.

1. Verify that the line power meets the requirements shown in the following table.

### Line Power Requirements

Power:	115 VAC: 110 VA MAX. / 60 WATTS MAX. / 1.1 A MAX. 230 VAC: 150 VA MAX. / 70 WATTS MAX. / 0.6 A MAX.
Voltage	nominal: 115 VAC / 230 VAC range 115 VAC: 90-132 V range 230 VAC: 198-254 V
Frequency	nominals: 50 Hz / 60 Hz range: 47-63 Hz

2. Connect the line-power cord to the instrument's rear-panel connector.

Getting Started

**Step 3. Connect the Line-Power Cable**

3. Connect the other end of the line-power cord to the power receptacle.

Various power cables are available to connect the HP 86120B to ac power outlets unique to specific geographic areas. The cable appropriate for the area to which the HP 86120B is originally shipped is included with the unit. The cable shipped with the instrument also has a right-angle connector so that the HP 86120B can be used while sitting on its rear feet. You can order additional ac power cables for use in different geographic areas. Refer to "AC Line-Power Cords" on page 7-19.



---

## Step 4. Connect a Printer

The HP 86120B can print hardcopies of measurement results on a printer. The output is ASCII text. If you don't have a printer, continue with "Step 5. Turn on the HP 86120B" on page 1-10.

- Using a standard parallel printer cable, connect the printer to the HP 86120B's rear-panel PARALLEL PRINTER PORT connector.

---

## Step 5. Turn on the HP 86120B

1. Press the front-panel LINE key. After approximately 20 seconds, the display should look similar to the following figure:

The front-panel LINE switch disconnects the mains circuits from the mains supply after the EMC filters and before other parts of the instrument.

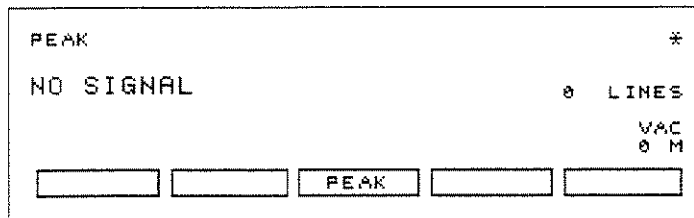

2. If the HP 86120B fails to turn on properly, consider the following possibilities:
  - Is the line fuse good?
  - Does the line socket have power?
  - Is it plugged into the proper ac power source?

If the instrument still fails, return it to Hewlett-Packard for repair. Refer to "Returning the Instrument for Service" on page 1-15.

**Instrument firmware version**

When the instrument is first turned on, the display briefly shows the instrument's firmware version number. In the unlikely event that you have a problem with the HP 86120B, you may need to indicate this number when communicating with Hewlett Packard.

**There is no output laser aperture**

The HP 86120B does not have an output laser aperture. However, light less than 1 nW escapes out of the front-panel OPTICAL INPUT connector. Operator maintenance or precautions are not necessary to maintain safety. No controls, adjustments, or performance of procedures result in hazardous radiation exposure.

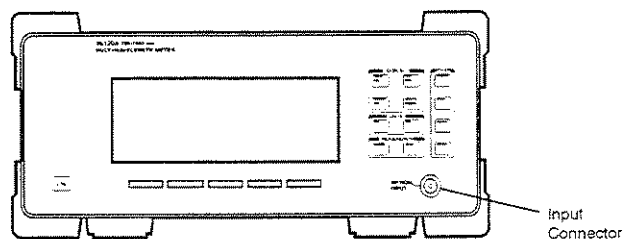

---

## Step 6. Enter Your Elevation

In order for your HP 86120B to accurately measure wavelengths and meet its published specifications, you must enter the elevation where you will be performing your measurements.

1. Press the Setup key.
2. Press the *MORE* softkey.
3. Press the *CAL* softkey.
4. Press *ELEV*.
5. Use the  $\uparrow$  and  $\downarrow$  softkeys to enter the elevation in meters. Entries jump in 500 meter steps from 0 m to 5000 m.

The elevation value selected with the softkeys must be within 250 meters of the actual elevation.

6. Press *RETURN* to complete the entry.

### **Converting feet to meters**

If you know your elevation in feet, you can convert this value to meters by using the following equation:

$$m = \frac{ft}{3.281}$$

---

## Step 7. Select Medium for Wavelength Values

Because wavelength varies with the material that the light passes through, the HP 86120B offers wavelength measurements in two mediums: vacuum and standard air.

1. Press the Setup key.
2. Press the *MORE* softkey.
3. Press the *CAL* softkey.
4. Make the following selection:
  - Press *VACUUM* for wavelength readings in a vacuum.
  - Press *STD AIR* for wavelength readings in standard air.
5. Press *RETURN* to complete the entry.

**Definition of standard air**

Standard air is defined to have the following characteristics:

Barometric pressure: 760 torr  
Temperature: 15°C  
Relative humidity: 0%

---

## Step 8. Turn Off Wavelength Limiting

After the Preset key is pressed, the input wavelength range is limited to measuring lasers between 1200 nm and 1650 nm. You can easily expand the input range to the full 700 nm to 1650 nm range with the following steps:

1. Press the Preset key.
2. Press the *MORE* softkey.
3. Press the Setup key.
4. Press the *WL LIM* softkey.
5. Press *LIM OFF* to remove the limits on wavelength range.

All responses in the full 700 nm to 1650 nm range are now displayed.

## Returning the Instrument for Service

The instructions in this section show you how to properly package the instrument for return to a Hewlett-Packard service office. For a list of offices, refer to "Hewlett-Packard Sales and Service Offices" on page 7-20.

If the instrument is still under warranty or is covered by an HP maintenance contract, it will be repaired under the terms of the warranty or contract (the warranty is at the front of this manual). If the instrument is no longer under warranty or is not covered by an HP maintenance plan, Hewlett-Packard will notify you of the cost of the repair after examining the unit.

When an instrument is returned to a Hewlett-Packard service office for servicing, it must be adequately packaged and have a complete description of the failure symptoms attached.

When describing the failure, please be as specific as possible about the nature of the problem. Include copies of additional failure information (such as instrument failure settings, data related to instrument failure, and error messages) along with the instrument being returned.

Please notify the service office before returning your instrument for service. Any special arrangements for the instrument can be discussed at this time. This will help the HP service office repair and return your instrument as quickly as possible.

## Preparing the instrument for shipping

1. Write a complete description of the failure and attach it to the instrument. Include any specific performance details related to the problem. The following information should be returned with the instrument.
  - Type of service required.
  - Date instrument was returned for repair.
  - Description of the problem:
    - Whether problem is constant or intermittent.
    - Whether instrument is temperature-sensitive.
    - Whether instrument is vibration-sensitive.
    - Instrument settings required to reproduce the problem.
    - Error codes.
    - Performance data.
  - Company name and return address.
  - Name and phone number of technical contact person.
  - Model number of returned instrument.
  - Full serial number of returned instrument.
  - List of any accessories returned with instrument.
2. Cover all front or rear-panel connectors that were originally covered when you first received the instrument.

---

**CAUTION**

Cover electrical connectors to protect sensitive components from electrostatic damage. Cover optical connectors to protect them from damage due to physical contact or dust.

---

**CAUTION**

Instrument damage can result from using packaging materials other than the original materials. Never use styrene pellets as packaging material. They do not adequately cushion the instrument or prevent it from shifting in the carton. They may also cause instrument damage by generating static electricity.

3. Pack the instrument in the original shipping containers. Original materials are available through any Hewlett-Packard office. Or, use the following guidelines:
  - Wrap the instrument in antistatic plastic to reduce the possibility of damage caused by electrostatic discharge.



- For instruments weighing less than 54 kg (120 lb), use a double-walled, corrugated cardboard carton of 159 kg (350 lb) test strength.
  - The carton must be large enough to allow 3 to 4 inches on all sides of the instrument for packing material, and strong enough to accommodate the weight of the instrument.
  - Surround the equipment with 3 to 4 inches of packing material, to protect the instrument and prevent it from moving in the carton. If packing foam is not available, the best alternative is S.D-240 Air Cap™ from Sealed Air Corporation (Commerce, California 90001). Air Cap looks like a plastic sheet filled with air bubbles. Use the pink (antistatic) Air Cap™ to reduce static electricity. Wrapping the instrument several times in this material will protect the instrument and prevent it from moving in the carton.
4. Seal the carton with strong nylon adhesive tape.
  5. Mark the carton "FRAGILE, HANDLE WITH CARE".
  6. Retain copies of all shipping papers.

Getting Started

**Returning the Instrument for Service**

---

## Making Measurements



---

## Making Measurements

In this chapter, you'll learn how to make a variety of fast, accurate measurements. As you perform these measurements, keep in mind the following points:

- 700 nm to 1650 nm maximum input wavelength range  
The range is normally limited from 1200 nm to 1650 nm. To use the full range, refer to "Measuring lasers between 700 nm and 1200 nm" on page 2-7 and to "To use the full wavelength range" on page 2-10.
- +10 dBm maximum total displayed input power
- Laser linewidths assumed to be less than 10 GHz
- If you change the elevation where you will be using your HP 86120B, refer to "Calibrating Measurements" on page 2-39.
- Press the green Preset key to return the HP 86120B to its default state.

---

### **CAUTION**

Do not exceed +18 dBm source power. The HP 86120B's input circuitry can be damaged when total input power exceeds 18 dBm. You can measure power levels that are greater by adding attenuation and entering a power offset as described in "To measure total power exceeding 10 dBm" on page 2-38.

**Contents**

Measuring Wavelength and Power 2-4  
    To display peak wavelength and power 2-9  
    To display multiple laser lines 2-9  
    To display average wavelength and total power 2-10  
    To use the full wavelength range 2-10  
    To limit the wavelength range 2-10  
    To see the graphical display 2-10  
    To save and recall an instrument state 2-11  
    To control the power bar 2-11  
Changing the Units and Measurement Rate 2-12  
    To change the units of measure 2-13  
    To select single measurement acquisition 2-13  
    To increase measurement speed 2-14  
Defining Laser-Line Peaks 2-15  
    To define laser-line peaks 2-18  
Measuring Laser Separation 2-19  
    To measure channel separation 2-21  
    To measure flatness 2-21  
Measuring Laser Drift 2-22  
    To measure drift 2-24  
Measuring Signal-to-Noise Ratios 2-26  
    To measure signal-to-noise 2-29  
Measuring Coherence Length 2-33  
    To measure coherence length 2-35  
Measuring Modulated Lasers 2-36  
Measuring Total Power Greater than 10 dBm 2-38  
    To measure total power exceeding 10 dBm 2-38  
Calibrating Measurements 2-39  
    To enter the elevation 2-40  
    To select the medium for light 2-40  
Printing Measurement Results 2-41  
    To create a hardcopy 2-42  
Cleaning Connections for Accurate Measurements 2-43  
    To clean a non-lensed connector 2-45  
    To clean an adapter 2-46  
    To test insertion loss and return loss 2-47

---

## Measuring Wavelength and Power

This section gives you step-by-step instructions for measuring peak wavelength, average wavelength, peak power, and total input power. There are three display modes:

- Peak wavelength
- List-by-wavelength *or* power
- Average wavelength and total power

The figure on this page shows the peak wavelength mode. The figure on the next page shows the list-by-wavelength display mode where the signals are displayed in order from shortest to longest wavelengths. In either mode, the HP 86120B can measure up to 100 laser lines simultaneously.

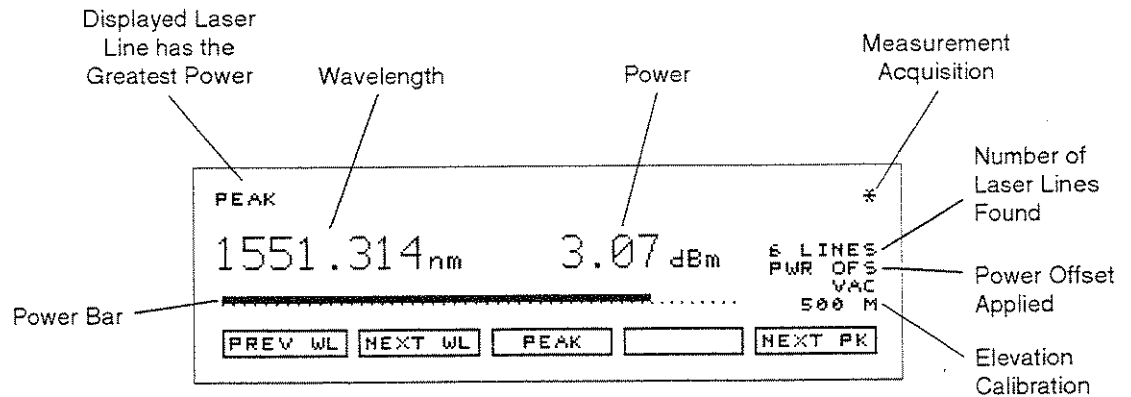

peakw2

**Display after "Peak WL" key pressed**

**Peak WL mode displays one signal**

When Peak WL is pressed, the display shows the largest amplitude line in the spectrum. The word PEAK is shown on the screen. If multiple laser lines are present at the input, the number of lines located will be shown along the right side of the screen.

In addition to the digital readouts, there is a power bar. It provides a convenient analog “meter movement” for tuning laser power.

Although the Peak WL mode shows one signal at a time, softkeys are provided that allow you to scroll through and display all the measured laser lines. You can scroll through the list according to the wavelengths or powers measured.

**List by WL or Power modes display multiple lines simultaneously**

In the list-by-wavelength or list-by-power modes, the measurements of five laser lines can be displayed at any one time. Use the  $\updownarrow$  and  $\leftarrow$  softkeys to move the cursor  $\leftrightarrow$  through the list of signals; the list can contain up to 100 entries. Press the SELECT key, and the display changes to peak wavelength mode with the signal at the cursor displayed.

Annotation in the upper right corner of the display indicates whether the signals are ordered according to wavelength (BY WL) or power (BY PWR). The cursor shows the currently selected laser line. As you scroll through the responses, the current position of the selection cursor is shown along the screen’s right side.

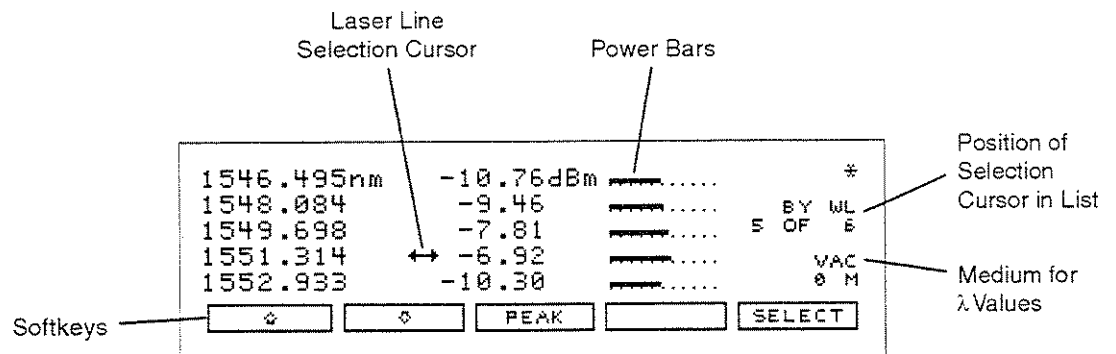

listwi

**Display after “List by WL” key pressed**

Also notice that power bars graphically show the relative power levels between laser lines.

## Making Measurements

### Measuring Wavelength and Power

#### **Total power and average wavelength can be measured**

In the third available display mode, the HP 86120B displays the average wavelength as shown in the following figure. The displayed power level is the total input power to the instrument. It is the sum of the powers of each laser line; it is *not* a measure of the average power level of the laser lines.

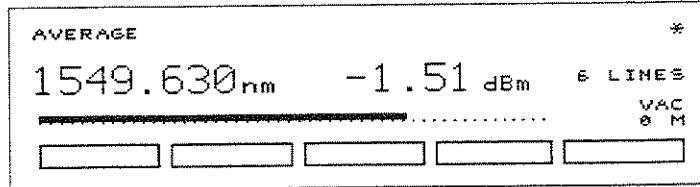

The following equation shows how individual wavelengths of laser lines are summed together to obtain the average wavelength value:

$$\lambda_{avg} = \frac{\sum_{i=1}^n P_i \lambda_i}{\sum_{i=1}^n P_i}$$

where,

$n$  is the number of laser lines included in the average.

$P_i$  is the peak power of an individual laser line. Power units are in Watts (linear).



The following equation shows how individual powers of laser lines are summed together to obtain the total power value:

$$P_{total} = \sum_{i=1}^n P_i$$

where,

$n$  is the number of laser lines included in the measurement.

$P_i$  is the peak power of an individual laser line. Power units are in Watts (linear).

### ***Measuring lasers between 700 nm and 1200 nm***

After the Preset key is pressed, the input wavelength range is limited to measuring lasers between 1200 nm and 1650 nm. This prevents the accidental display of spurious signals that may not exist. You can easily expand the input range to the full 700 nm to 1650 nm range, however you should learn how to identify spurious signals.

Spurious signals below 1200 nm may be displayed whenever low-power laser lines (power levels near the HP 86120B's specified sensitivity) are present at the input. For example, a low-power laser line at 1550 nm has a second harmonic line at 775 nm. If this second harmonic is above the peak threshold level relative to the fundamental line, it is considered a peak. Its displayed power level may be *greater* than that of the fundamental because the amplitude correction at 775 nm is much greater (by about 15 dB) than that at 1550 nm (the interferometer is less sensitive at 775 nm).

You can also avoid displaying this second harmonic line by reducing the peak threshold below its preset value. Because the peak threshold level is used to determine which signals are to be displayed *before* amplitude corrections are applied, the harmonic will be eliminated. Refer to "Defining Laser-Line Peaks" on page 2-15.

In order to use the full wavelength range, refer to "To use the full wavelength range" on page 2-10.

### ***Limiting the wavelength range of measurement***

The wavelength range of measurement can be limited with the wavelength limit function. Both start and stop wavelengths can be chosen. The units of wavelength start and stop are the same as the currently selected wavelength units. If wavelength units are later changed, the start and stop wavelength

## Making Measurements

### Measuring Wavelength and Power

units will change accordingly. Note that a start wavelength limit in nm will become a stop wavelength limit if THz or  $\text{cm}^{-1}$  is chosen. See "To change the units of measure" on page 2-13.

The wavelength limit can be useful when laser modulation causes spurious wavelengths to be displayed. Reducing the wavelength range to the region of interest minimizes the number of spurious wavelengths displayed. Also, the graphical display uses these start and stop wavelength values to plot the power spectrum, whether the wavelength limit function is on or off.

Preset will turn the wavelength limit on and will set the start wavelength to 1200 nm and the stop wavelength to 1650 nm.

#### ***Graphical display of optical power spectrum***

A graphical display of optical power versus wavelength is shown from the start wavelength value to the stop wavelength value. The start wavelength value is shown in the upper left corner of the graphical display, and the stop wavelength value is shown in the upper right corner of the graphical display. The power scale is a fixed dB scale, with +10 dBm at the display top and -53 dBm at the display bottom. The power scale is not affected by the Power Offset value. In most cases, the noise floor will be visible if the total input power is greater than about -5 dBm.

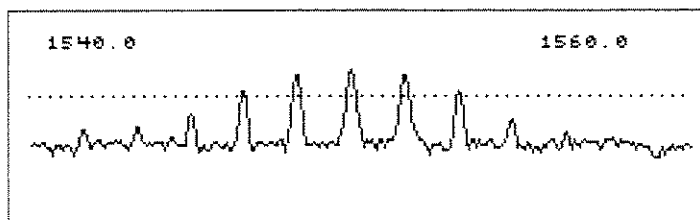

#### **The HP 86120A graphical display.**

The Peak Threshold value is displayed as a dotted line. All peaks above this dotted line are displayed in the List by Wavelength and List by Power modes. All peaks below this line are not displayed. Adjust the Peak Threshold value with the Setup key, and the *THRSHLD* softkey.

The wavelength limit start and stop wavelength values are used for the graphical display even if the wavelength limit function is off.

The graphical display cannot be printed.

### ***Saving and Recalling instrument states***

Four different instrument states can be saved and recalled at a later time. The actual instrument conditions that are saved are identical to those saved from the previous state after power is turned on. These conditions are shown in Table 7-1 on page 7-3. Note if drift measurements or an application (such as signal-to-noise) is on when an instrument state is saved, it is off when that state is recalled.

---

### To display peak wavelength and power

1. Connect the fiber-optic cable to the front-panel OPTICAL INPUT connector.
2. To display the peak wavelength and power, do one of the following:
  - Press the green Preset key.
  - Press *Peak WL*.
3. To move the cursor to view other signals, press:
  - *PREV WL* to select next (previous) shorter wavelength.
  - *NEXT WL* to select next longer wavelength.
  - *PEAK* to signal with greatest power.
  - *PREV PK* to select next lower power signal.
  - *NEXT PK* to select next higher power signal.

---

### To display multiple laser lines

1. Connect the fiber-optic cable to the front-panel OPTICAL INPUT connector.
2. Press the green Preset key.
3. Press *List by WL* to display the laser lines from the shortest wavelength to the longest wavelength.
4. Press *List by Power* to display the laser lines in order of decreasing amplitudes.

Making Measurements  
**Measuring Wavelength and Power**

---

**To display average wavelength and total power**

- Press the Avg WL key.
- 

**To use the full wavelength range**

1. Press the Setup key.
  2. Press the *WL LIM* softkey.
  3. Press *LIM OFF* to remove the limits on wavelength range. All responses in the full 700 nm to 1650 nm range are now displayed.
- 

**To limit the wavelength range**

1. Press the Setup key.
  2. Press the *WL LIM* softkey.
  3. Press the *LIM ON* softkey if it is not already highlighted.
  4. Press the *STARTWL* softkey to adjust the start wavelength value.
  5. Press the *STOP WL* softkey to adjust the stop wavelength value.
- 

**To see the graphical display**

1. Press the List by WL or List by Power key.
  2. Press the *GRAPH* softkey.
  3. To exit the graphical display, press any softkey.
-

## To save and recall an instrument state

To save a state:

1. Press the Setup key.
2. Press the *SAV/RCL* softkey.
3. Press the *SAVE* softkey.
4. Press one of the four *SAVE* softkeys to save the instrument state.

To recall a state:

1. Press the Setup key.
  2. Press the *SAV/RCL* softkey.
  3. Press the *RECALL* softkey.
  4. Press one of the four *RCL* softkeys to recall an instrument state.
- 

## To control the power bar

1. Press the Setup key.
2. Press *MORE* twice, and then *PWR BAR*.
3. Press *BAR ON* to display the power bar, and press *BAR OFF* to hide the power bar display.

---

## Changing the Units and Measurement Rate

### *Change the displayed units*

As described later in this section, it's easy to change the wavelength and amplitude units. You can choose between the following units:

**Table 2-1. Available Units**

Wavelength	Power
nm	dBm
cm <sup>-1</sup>	mW
THz	μW

### *You can speed up the measurement rate*

Under normal operation, the HP 86120B makes a measurement and displays the results about once every second. It is in this normal update mode that maximum accuracy and wavelength resolution are achieved. However, should a faster update be desired, for example when real-time feedback is required to tune a laser to its designated channel, the HP 86120B can be set to update approximately three times per second. This reduces both wavelength resolution and accuracy but can be beneficial in some applications.

When *FAST* update is selected, one less digit of resolution is displayed. Also, if multiple wavelengths are present, these individual responses, with the reduced resolution, may no longer be recognized.

### *Select continuous or single measurements*

The HP 86120B continuously measures the input spectrum at the front-panel OPTICAL INPUT connector. Whenever measurements are being acquired, an asterisk (\*) is displayed in the display's upper right corner. When you switch between normal and fast update modes the rate that the asterisk blinks changes.

You can specify that the instrument perform a measurement only when the front-panel *Single* key is pressed. This is the single-acquisition measurement mode, and it is useful for capturing and preserving data. After capturing the data, you can display it using many of the procedures included in this chapter. You can return to continuous measurement mode at any time by pressing the *Cont* key.

---

### To change the units of measure

1. Press *Setup*.
  2. Press the *MORE* softkey.
  3. Press the *UNITS* softkey.
  4. Press *WL* and select one of the following units. Then, press *RETURN* to complete your selection:
    - *NM* for nanometers
    - *THZ* for terahertz
    - *CM<sup>-1</sup>* for wave number
  5. Press *POWER* and select one of the following units:
    - *DBM* for decibels relative to a milliwatt
    - *MW* for milliwatts
    - *UW* for microwatts
- 

### To select single measurement acquisition

- Press the *Single* key.
-

### To increase measurement speed

1. Press the Setup key.
2. Press the *MORE* softkey.
3. Press the *UPDATE* softkey.
4. Select either *NORMAL* or *FAST*.



## Defining Laser-Line Peaks

The HP 86120B uses two rules to identify valid laser-line peaks. Understanding these rules is essential to getting the most from your measurements. For example, these rules allow you to “hide” AM modulation sidebands or locate laser lines with small amplitudes.

In order to identify a laser line, the laser-line must meet *both* of the following rules:

- Power must be greater than the power established by the *peak threshold limit*
- Power must rise and then fall by at least the *peak excursion* value

In addition, the input wavelength range can be limited as described in this section.

### ***Peak threshold limit***

The peak threshold limit is set by subtracting the peak threshold value from the power of the largest laser line. So, if the largest laser line is 2 dBm and the peak threshold value is 10 dB, the peak threshold limit is -8 dBm ( $-8 \text{ dBm} = 2 \text{ dBm} - 10 \text{ dB}$ ). You can set the peak threshold value between 0 to 40 dB.

The peak threshold's default value is 10 dB. This ensures that any modulated signals being measured are not confused with their AM sidebands. For unmodulated lasers, or Fabry-Perot lasers, it may be desirable to increase this threshold to look for responses that are more than 10 dB from the peak.

Peak threshold can be used to suppress spurious signals. For example, a laser that is amplitude modulated in the audio frequency range can cause spurious wavelengths to be displayed below and above the correct wavelength. The power of these spurious wavelengths is below that of the correct wavelength. These spurious signals can be eliminated by decreasing Peak threshold from its Preset value.

## Making Measurements

### Defining Laser-Line Peaks

#### **Peak excursion**

The peak excursion defines the rise and fall in amplitude that must take place in order for a laser line to be recognized. The rise and fall can be out of the noise, or in the case of two closely spaced signals, out of the filter skirts of the adjacent signal. The peak excursion's default value is 15 dB. Any laser line that rises by 15 dB and then falls by 15 dB passes the rule. You can set the peak excursion value from 1 to 30 dB.

#### **Examples of valid and invalid signals**

In the following figure, three laser lines are identified: responses ①, ③, and ④. Response ② is not identified because it is below the peak threshold. The portion of each signal that is within the peak excursion limits is shown in bold lines.

Because of the peak excursion rule, responses ④ and ⑤ are identified as one laser line—the minimum point between ④ and ⑤ does not drop to the peak excursion limit. This response has the highest power shown which is peak ④.

Whenever the peak threshold limit or peak excursion value is changed, the new limits are applied to the current displayed measurements even if the instrument is in the Single measurement mode.

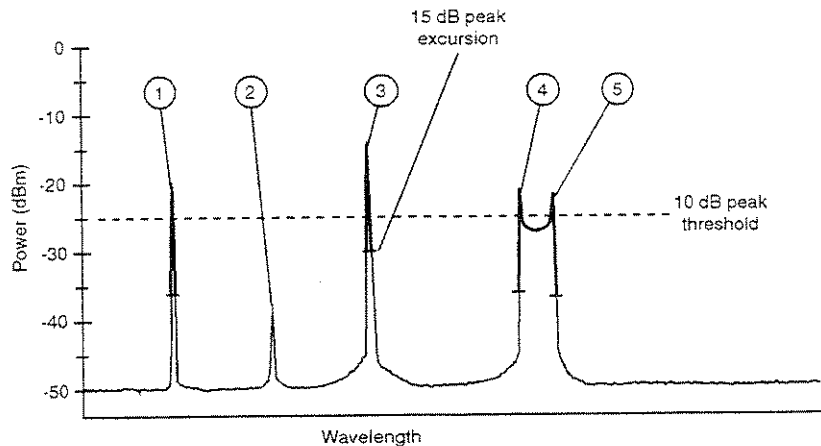

wavth15

The following figure shows the same laser lines as the previous figure, but the peak-excursion value has been changed from 15 to 3 dB. Four laser lines are now identified with responses ④ and ⑤ identified as two distinct laser lines.

**Limiting the input wavelength range**

The HP 86120B's preset condition limits the wavelength measurement range from 1200 nm to 1650 nm. You can expand the wavelength range to cover the entire 700 nm to 1650 nm range. Although wavelength range limiting reduces the number of laser lines found, its main purpose is to eliminate the identification of second harmonic distortion products as described in the following sidebar. To set the wavelength range, refer to "To use the full wavelength range" on page 2-10.

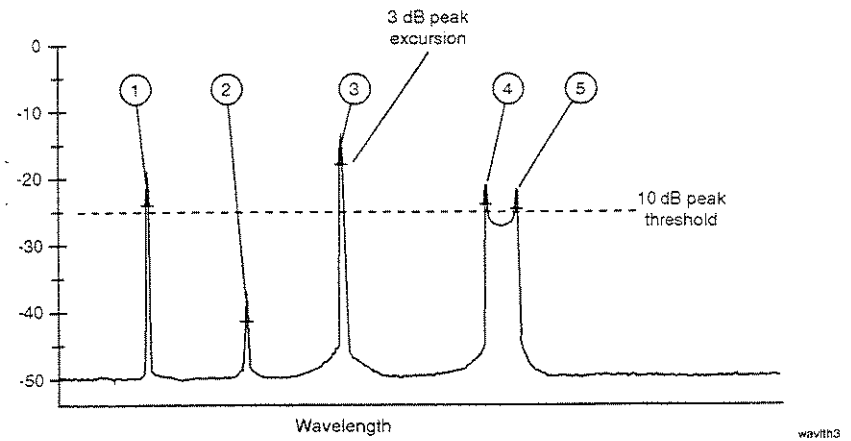

**Distortion caused by low-power laser lines**

Low-power laser lines (power level near the HP 86120B's specified sensitivity) may be accompanied by second harmonic (or other) distortion. For example, a low-power laser line at 1550 nm has a second harmonic line at 775 nm. If this second harmonic is above the peak threshold level relative to the fundamental line, it is considered a peak. Its displayed power level may be *greater* than that of the fundamental because the amplitude correction at 775 nm is much greater (by about 15 dB) than that at 1550 nm (the interferometer is less sensitive at 775 nm).

To avoid displaying this second harmonic line, limit the input wavelength range from 1200 nm to 1650 nm as described in "To use the full wavelength range" on page 2-10.

Or, reduce the peak threshold below its preset value. Because the peak threshold level is used to determine which signals are to be displayed *before* amplitude corrections are applied, the harmonic will be eliminated.

## To define laser-line peaks

1. Press the Setup key.
2. Press the *THRSHLD* softkey.
3. Press *PX EXC*, and enter the peak excursion value. Use the  $\rightarrow$  softkey to select the digit that requires editing. Use the  $\uparrow$  and  $\downarrow$  softkeys to change the value.

The peak excursion value can range from 1 to 30 dB. The default value is 15 dB.

4. Press *RETURN*.
5. Press *PK THLD* and then enter the peak threshold value.

The peak threshold value can range from 0 to 40 dB. Setting this value to 0 dB ensures that only the peak wavelength is identified. The default value is 10 dB.

Pressing the green PRESET key changes the peak excursion and peak threshold values to their default settings. It also turns wavelength range limiting on. Turning the HP 86120B's power off and then on does not change these settings.

### **If too many lines are identified**

If the following message is displayed, too many laser lines have been identified:

E15 MAX NUMBER OF SIGNALS FOUND

The maximum number of laser lines that the instrument can measure is 100. If this message appears, decrease the peak threshold value, increase the peak excursion value, or decrease the wavelength range of operation with the *WL LIM*, *START WL* and *STOP WL* functions.

---

## Measuring Laser Separation

It is often important to measure the wavelength and power separation between multiple laser lines. This is especially true in wavelength-division-multiplexed (WDM) systems where channel spacing must be adhered to. The HP 86120B can display the wavelength and amplitude of any laser line relative to another. In fact, the following types of relative measurements can be made compared to the reference:

- Relative wavelength, absolute power
- Relative power, absolute wavelength
- Relative wavelength and power

For example, suppose that you want to measure separation on a system having the spectrum shown in the following figure.

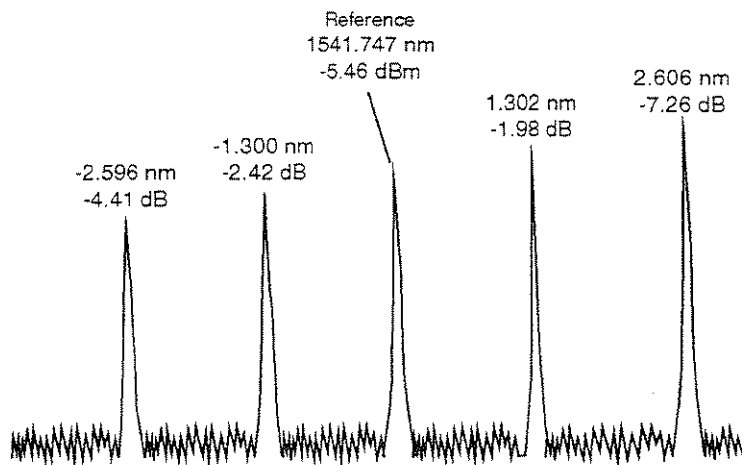

peaks

## Making Measurements

### Measuring Laser Separation

The HP 86120B displays separation on this spectrum as shown in the following figure. Notice that the 1541.747 nm laser line is selected as the reference. It is shown in absolute units. The wavelengths and powers of the remaining responses are shown relative to this reference. For example, the first response is 2.596 nm below the reference.

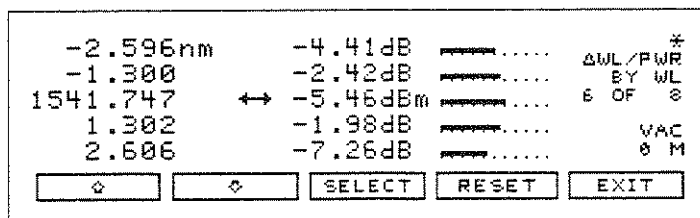

To determine channel spacing, simply read the relative wavelength measurement of the laser lines immediately preceding and following the reference. Use the  $\diamond$ ,  $\diamond$ , and *SELECT* softkeys to change the reference laser line and read the channel spacing between each channel.

You can use relative power measurements to measure flatness (pre-emphasis) in a WDM system. Simply select one carrier as the reference and measure the remaining carriers relative to the reference level. The power differences represent the system flatness.

Press *RESET* to turn off the delta calculations so that all responses are shown in absolute wavelength and powers.

## To measure channel separation

1. Press the front-panel Preset key.
  2. Press List by WL.
  3. Press the Delta On key.  
Use the Off key to turn off the measurement.
  4. Select the type of separation to observe:
    - $\Delta WL$  displays channel separation.
    - $\Delta WL / \Delta PWR$  displays both channel separation and differences in power.
  5. Use the  $\uparrow$  and  $\downarrow$  softkeys to select the reference laser line.
  6. Press *SELECT*.  
Press *SELECT* at any time to select a new reference. Press *RESET* at any time to turn off the delta calculation.
- 

## To measure flatness

1. Press the front-panel Preset key.
  2. Press List by Power.  
This lists the input signals by power with the largest response listed first.
  3. Press the Delta On key.
  4. Select  $\Delta PWR$ .
  5. Use the  $\uparrow$  and  $\downarrow$  softkeys to select the first laser line.
  6. Press *SELECT*.
  7. Since the largest power signal is the reference, the relative power measurements for the other responses shows system flatness.
-

## Measuring Laser Drift

In this section, you'll learn how the HP 86120B can be used to monitor drift (changes to a laser's wavelength and amplitude over time). Drift is measured simultaneously for every laser line that is identified at the input. The HP 86120B keeps track of each laser line's initial, current, minimum, and maximum values and displays their differences relative to itself. This allows the HP 86120B to be used for laser transmitter evaluation, burn-in, or development. In addition, you can monitor system performance over time, temperature, or other condition.

The following display shows power and wavelength drift measured on five laser lines. The **DRIFT** annotation, item ①, tells you that drift measurements are being performed. The current relative drift values for wavelength and power are shown in items ② and ③ respectively. Item ④ indicates the absolute reference values for the laser line indicated by the cursor  $\leftrightarrow$ . The reference values are measured before the measurement starts.

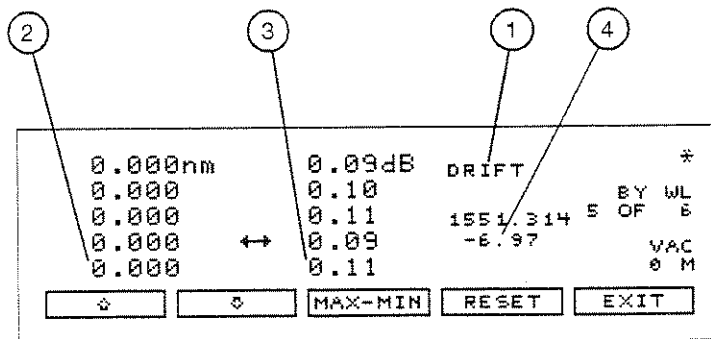

drift

You can restart the drift measurement at any time by pressing the **RESET** soft-key. All minimum and maximum values are reset to the reference values, and the HP 86120B begins to monitor drift from the current laser line values. Move the cursor up and down the listing to see the reference wavelength and power of each laser line.



**If measurement updating stops or the values become blanked**

If, in the middle of a measurement, the number of laser lines present changes, the measurement stops until the original number of lines returns. You'll notice that a *CLEAR* soft-key appears and one of the following message is displayed:

E46 NUM LINES < NUM REFS

E47 NUM LINES > NUM REFS

To view the data measured before the conditions changed, press *CLEAR* and then *MAX-MIN*. Notice that the measurement acquisition is changed from continuous to single.

To restart testing, press *CLEAR*, the *CONT* key, and then *RESET* to use the new number of lines as the reference. Pressing *CONT* restarts continuous measurement acquisition. Or, you can restore the original number of lines on the input so that the drift measurement can continue.

## To measure drift

1. Press the front-panel Preset key.
2. Press Peak WL, List by WL, or List by Power to select the display style for observing drift.
3. Press Appl's and then *DRIFT*.

Pressing *DRIFT* sets the current laser-line values as the reference from which to compare all drift.

4. Press *MAX-MIN* for the desired type of drift measurement as described in the following paragraphs:

**MAX-MIN**

Display shows the current values of laser lines relative to the wavelength and power values measured when the test was begun or the *RESET* softkey was pressed.

**MAX-MIN**



Display shows absolute maximum values since the drift measurement was started. This measurement gives the *longest* wavelength and *greatest* power measured. The laser line of interest may have since drifted to a lesser value. Note that the maximum wavelength and maximum power may not have occurred simultaneously.

**MAX-MIN**

Display shows absolute minimum values since the drift measurement was started. This measurement gives the *shortest* wavelength and *smallest* power measured. The laser line of interest may have since drifted to a greater value. Note that the minimum wavelength and minimum power may not have occurred simultaneously.

**MAX-MIN**

Display shows the *total* drift from the reference since the drift measurement was started. Values represent the minimum wavelength and power drift values subtracted from the maximum drift values.

5. In the List by WL and List by Power displays, use the  and  softkeys to view the reference values (wavelength and power values of each laser line before the test was started).

During the measurement, you can change the display mode to Peak WL, List by WL, List by Power, or Avg WL. When List by WL or List by Power is selected, the signal list is sorted by reference values and not by the current, maximum, or minimum values.

To restart the drift measurements, press *RESET*. This resets the reference values.

## Measuring Signal-to-Noise Ratios

Signal-to-noise measurements provide a direct indication of system performance. Signal-to-noise measurements are especially important in WDM systems because there is a direct relation between signal-to-noise and bit error rate. The HP 86120B displays signal-to-noise measurements in the third column. For example, the selected signal in the following figure has a signal-to-noise ratio of 30.0 dB.

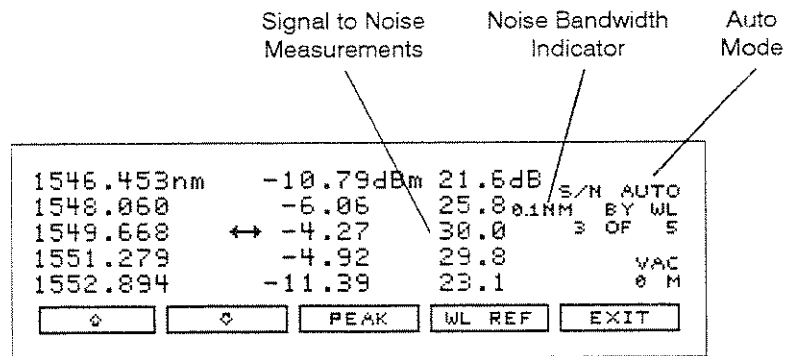

snr

### Signal-to-noise display.

#### ***Understanding how measurements are made is critical***

During a signal-to-noise measurement, the absolute power of the carrier, in dBm, is compared to the absolute power of the noise at the carrier wavelength. See the following figure. The noise power at the carrier must be determined by interpolation because the carrier, in most cases, can not or should not be turned off.

You can select one of two methods used to determine the wavelength where the noise is measured: automatic interpolation or a user-entered wavelength. In the figure above, notice that "S/N AUTO" is displayed to indicate that automatic interpolation is selected.

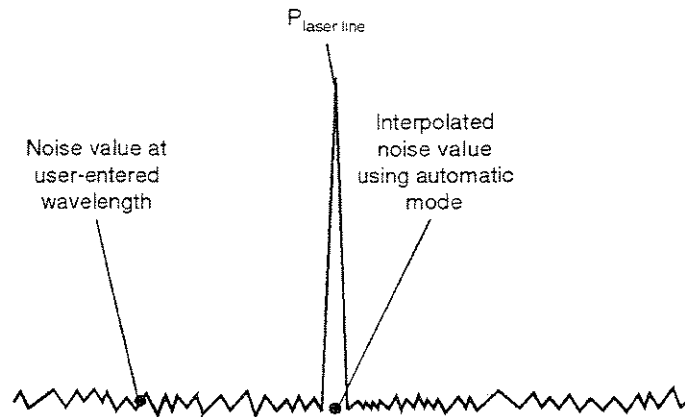

peak

#### Location of noise measurements

##### ***Automatic interpolation***

When the signal-to-noise "auto" function is selected, the HP 86120B first determines the proximity of any adjacent signal. If the next closest signal is  $\leq 200$  GHz (approximately 1.6 nm at 1550 nm) away from the signal of interest, then the noise power is measured half way between the two channels and an equal distance to the other side of the signal of interest. See points  $P_{n1}$  and  $P_{n2}$  in the following figure.

If the closest signal is more than 200 GHz from the signal of interest, or if there is no other signals present, then the noise power is measured at 100 GHz on either side of the signal of interest. The two measured noise power levels are then averaged to estimate the noise power level at the signal wavelength. The noise power measurements use linear interpolation to estimate the noise power level at the signal of interest's wavelength.

## Making Measurements

### Measuring Signal-to-Noise Ratios

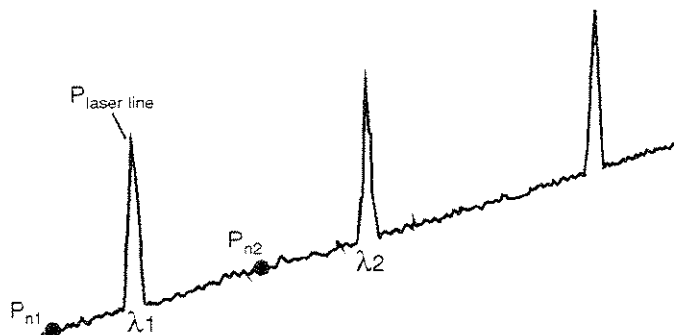

sun

#### Automatic interpolation

##### *User-entered wavelength*

When the signal-to-noise “user” function is selected, the HP 86120B uses only one wavelength to measure the noise power for all signals. This wavelength is set by the user and all signals are compared to the noise level at this wavelength to determine their corresponding signal-to-noise ratios

##### *Noise bandwidth affects measurement*

When measuring noise power, the HP 86120B must account for the noise bandwidth used during the measurement. Because noise bandwidth varies with measurement bandwidth (a wide bandwidth allows more noise to the HP 86120B's detector than a narrow bandwidth), the HP 86120B normalizes all noise power measurements to a bandwidth of 0.1 nm. The annotation 0.1 nm is displayed to show that the noise bandwidth is being normalized to a 0.1 nm bandwidth.

#### **Repetitive data formats**

The HP 86120B signal-to-noise application works best when the laser being tested is not modulated, or modulated with non-repetitive data formats. With repetitive data formats, such as PRBS data and SONET formats, there is significant low-frequency amplitude modulation of the laser. This modulation raises the noise floor of the HP 86120B significantly. The signal-to-noise measured can be limited to about 15 dB while measuring lasers modulated by repetitive data formats. For improved performance when the laser is modulated with repetitive data formats, use the Signal-to-Noise with Averaging application.

## To measure signal-to-noise

1. Press the front-panel Preset key.
2. Press List by WL or List by Power.
3. Press Appl's and then *S/N*.
4. To select the wavelength reference for measuring the noise, do the following steps:
  - a. Press *WL REF*, and
    - press *AUTO* to let the instrument interpolate the wavelength,  
or
    - press *USER* to select the last wavelength manually entered.
  - b. If you chose *USER*, you can specify the wavelength by pressing *USER WL*. Use the  $\rightarrow$  softkey to select the digit that requires editing. Use the  $\uparrow$  and  $\downarrow$  softkeys to change the value.
  - c. Press *RETURN*.
5. While the signal-to-noise measurements are displayed, you can press *PEAK* anytime to select the signal with the highest power.

## Measuring Signal-to-Noise Ratios with Averaging

When the lasers being measured are modulated, especially with repetitive data formats such as SONET or PRBS, the noise floor is raised. Averaging reduces the noise floor and allows an improvement of greater than 10 dB in a signal-to-noise measurement. In general, averaging will decrease the noise floor caused by modulation until the true optical noise level is reached. The displayed signal-to-noise will improve with each average until the true optical noise level is reached, and then the displayed signal-to-noise will remain approximately constant. If, however, the true signal-to-noise is below the instrument sensitivity of approximately 40 dB (in a 0.1 nm noise bandwidth), it will not be measured.

Averaging can also improve the accuracy of measuring signal-to-noise of unmodulated lasers.

1546.454nm	-10.81dBm	31.7dB	S/N A100
1548.060	-6.06	36.7	0.1NM BY WL
1549.669	↔ -4.28	37.8	3 OF 5
1551.281	-4.94	37.0	VAC
1552.894	-11.22	33.4	0 M
<div style="display: flex; justify-content: space-between; margin-top: 10px;"> <span>⏪</span> <span>⏩</span> <span>PEAK</span> <span>HUM AVG</span> <span>EXIT</span> </div>			

**Signal-to-noise with averaging display.**



**Measuring Signal-to-Noise Ratios with Averaging*****Understanding how measurements are made is critical***

Averaging is performed on the noise, not on the wavelength or power of the laser signals.

The signal-to-noise with averaging measurement uses the automatic interpolation method to determine the wavelengths where the noise is measured. See "Measuring Signal-to-Noise Ratios" for a description of automatic interpolation. There is no user-entered wavelength selection in signal-to-noise with averaging.

During a signal-to-noise with averaging measurement, the display indicates  $S/N A_{xx}$ , where A indicates averaging and xx is the number of averages taken so far. The maximum number of averages is 900, the minimum number of averages is 10, and the default (Preset) value is 100 averages. A measurement with 100 averages takes about 2 minutes to complete. When the measurement is complete, the instrument switches to single measurement mode. Then, pressing the Cont key will start a completely new measurement. During a measurement and before the number of averages has been reached, pressing the Single key will stop the measurement. Then, pressing the Cont key will continue with the current measurement.

While making a signal-to-noise with averaging measurement, the number of averages can be changed. As long as the new number of averages is greater than the number of averages taken so far, the measurement continues. If the new number of averages selected is less than the number of averages taken so far, the measurement stops and the instrument switches to single measurement mode. Then, pressing the Cont key will start a completely new measurement.

***Noise bandwidth affects measurement***

When measuring noise power, the HP 86120B must account for the noise bandwidth used during the measurement. Because noise bandwidth varies with measurement bandwidth (a wide bandwidth allows more noise to the HP 86120B's detector than a narrow bandwidth), the HP 86120B normalizes all noise power measurements to a bandwidth of 0.1 nm. The annotation 0.1 nm is displayed to show that the noise bandwidth is being normalized to a 0.1 nm bandwidth.

## To measure signal-to-noise with averaging

1. Press the front panel Preset key.
2. Press *List by WL* or *List by Power*.
3. Press *App'l's* and then *S/N AVG*.
4. To change the number of averages, press *NUM AVG*. The default (Preset) value is 100.
5. To stop the measurement at the current number of averages shown, press the *Single* key. Then press the *Cont* key to continue the present measurement.
6. When the measurement is complete, the instrument will switch to the single measurement mode and stop.
7. To make a new measurement, press the *Cont* key.
8. To exit, press the *EXIT* softkey, then press the *Cont* key for continuous measurement.

---

## Measuring Coherence Length

Coherence length is a measure of the distance over which a laser's light retains the phase relationships of its spectrum. The HP 86120B measures coherence length of Fabry-Perot semiconductor diode lasers. The HP 86120B cannot measure coherence length of light emitting diodes (LEDs) or distributed feedback (DFB) lasers.

When you select coherence length measurements, the HP 86120B displays the following four values:

- Coherence length ( $L_c$ )
- Round trip optical length of diode laser cavity ( $2nL_D$ )
- Alpha factor
- Beta factor

Coherence length in the region of 1 mm to 200 mm can be measured. The following figure shows a coherence length measurement.

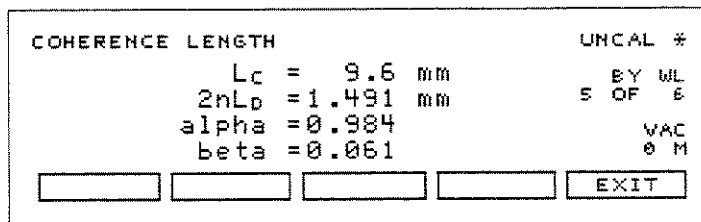

### ***Coherence length ( $L_c$ )***

The interferogram of the laser being tested is sampled and the envelope of the interferogram is found. This envelope has peaks (regions of high fringe visibility) at zero optical path delay and at delays equal to multiples of the laser cavity round-trip optical length. This is shown in the following figure of the interferogram envelope:

## Making Measurements

### Measuring Coherence Length

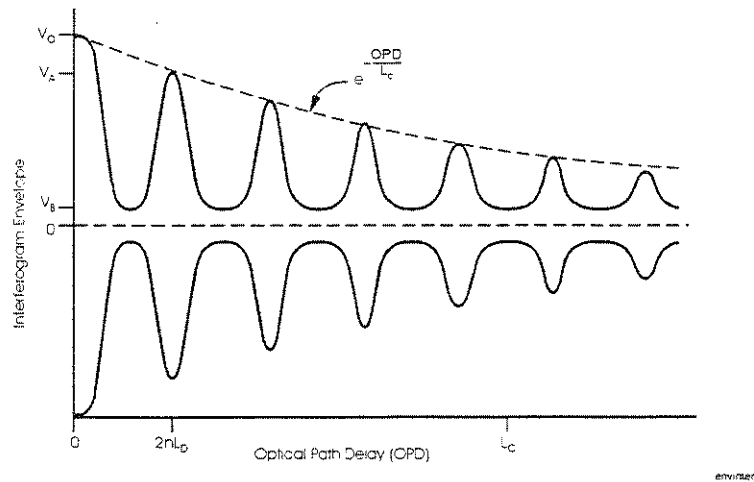

The amplitudes of the peaks decreases exponentially from the largest peak at zero path delay. The exponential decay constant is defined as the coherence length,  $L_c$ . The curve that connects the tops of the envelope peaks is given by the following equation:

$$\text{decay curve} = e^{-\frac{OPD}{L_c}}$$

OPD is the optical path delay and  $L_c$  is the coherence length. Thus, at an optical path delay equal to the coherence length, the envelope peaks are down to  $1/e$  of their value at zero path delay peak. All envelope peaks found are used to determine the exponential decay constant (coherence length) using a least squares fit.

#### **Round trip optical length of diode laser cavity ( $2nL_d$ )**

The average optical path delay spacing of the envelope peaks is measured. This is equal to the diode laser cavity round trip optical length,  $2nL_d$ .

#### **Alpha factor**

The alpha factor is defined as the height of the first envelope peak away from zero path delay relative to the height of the envelope peak at zero path delay. The alpha factor is always between 0 and 1.

The *smaller* the alpha factor, the shorter the coherence length.

$$\text{Alpha factor} = \frac{V_A}{V_o}$$

***Beta factor***

The beta factor is defined as the height of the fringe visibility envelope midway between the zero optical path delay peak and the next peak relative to the height of the envelope peak at zero path delay. The beta factor is always between 0 and 1.

The *smaller* the beta factor, the more longitudinal modes (wavelengths) the laser has.

$$\text{Beta factor} = \frac{V_B}{V_o}$$

---

## To measure coherence length

1. Press the front-panel Preset key.
2. Press Appl's and then *COHLEN*.

## Measuring Modulated Lasers

A laser that is amplitude modulated at low frequencies (for example, modulated in the audio frequency range) can cause spurious wavelengths to be displayed below and above the correct wavelength. The power of these spurious wavelengths is below that of the correct wavelength. These spurious signals can be eliminated by decreasing the peak threshold. Refer to "Defining Laser-Line Peaks" on page 2-15. Even when the laser is amplitude modulated, the correct wavelength and power is displayed. The spurious wavelengths caused by low frequency amplitude modulation will be located above and below the correct wavelength by the following wavelength spacing:

$$spacing = 6 \times 10^{-10} F \lambda^2$$

where  $F$  is the modulation frequency in Hz, and  $\lambda$  is the correct wavelength in nm. For example, an amplitude modulation of 10 kHz on a 1550 nm laser will produce spurious wavelengths spaced by 15 nm from the correct wavelength, and the spurious wavelengths will be at 1535 and 1565 nm.

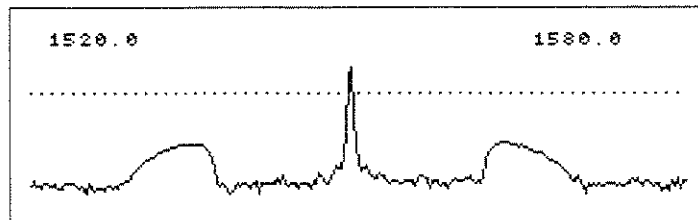

**Low frequency (10 kHz) AM modulation graph showing rounded sideband spurs.**

The graphical display is useful for locating these spurious wavelengths. Their amplitude will be below that of the correct wavelength and they will be broad, rounded peaks compared to the sharp peak of the correct wavelength. Use the Peak Threshold function to place the dotted line above the spurious peaks so they will not be displayed in the List by WL or List by Power table.

A laser modulated at high frequency (in the RF or microwave range) can also cause spurious wavelengths to be displayed, especially when the modulation is of a repetitive nature such as that of PRBS or SONET digital formats. In general, no spurious wavelengths will be displayed using preset instrument conditions. The preset condition includes peak excursion, peak threshold, and wavelength range limiting. However, increasing peak threshold can cause spurious wavelengths to be displayed. To control the wavelength range, refer to "To use the full wavelength range" on page 2-10.

Even when the laser being tested is modulated with repetitive formats, the carrier's correct wavelength and power is displayed; the wavelength and power of the spurious sidebands are incorrect.

The graphical display is useful to see the effects of high frequency modulation. Without modulation, the noise floor is typically 45 dB below the laser power. In general, high frequency modulation will raise the noise floor to about 25 dB below the laser power. The noise floor is typically flat, or white. The actual level of the noise floor depends on the type of data format and the data rate.

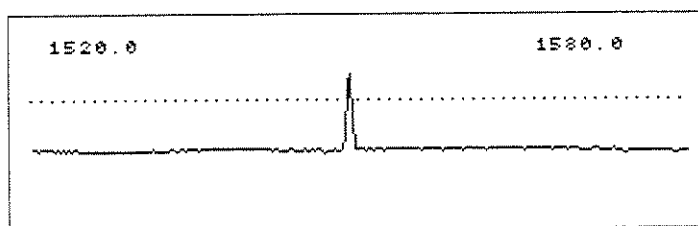

**PRBS modulation graph showing raised noise floor.**

---

## Measuring Total Power Greater than 10 dBm

The maximum total power that can be measured by the HP 86120B is 10 dBm. However, with the addition of an external attenuator, more power can be applied. This may be necessary at the transmit end of a wavelength-division-multiplexed system where large signal levels are present. By entering an amplitude offset equal to the amount of attenuation at the instrument's input, accurate amplitude measurements are shown on the display. Additional amplification can also be accounted for.

---

### To measure total power exceeding 10 dBm

The maximum total input power that can be applied to the HP 86120B before damage occurs is 18 dBm. The maximum total input power that can be measured is 10 dBm.

1. Connect an optical attenuator between the front-panel OPTICAL INPUT connector and the fiber-optic cable.

The attenuator must reduce the total input power to the HP 86120B so that it is below +10 dBm.

2. Press *Setup*, *MORE*, *CAL*, and then *PWR OFS*.

Notice that the *PWR OFS* annotation appears on the screen to indicate an offset is applied.

3. Use the  $\rightarrow$  softkey to select the digit that requires editing.
4. Use the  $\uparrow$  and  $\downarrow$  softkeys to change the value.

Power offset values are added to the display power readings. For example, if you placed a 10 dB attenuator on the front-panel connector, enter a power offset value of +10 dB. Negative values can also be entered if you connect an amplifier instead of an attenuator.



---

## Calibrating Measurements

The wavelength of light changes depending on the material that the light is passing through. To display meaningful wavelength measurements, the HP 86120B performs two steps:

1. Measures the wavelength in air.
2. Converts the wavelength to show values in either a vacuum or “standard air”.

For example, a laser line with a wavelength of 1550.000 nm in a vacuum would have a wavelength in standard air of 1549.577 nm.

Because all measurements made inside the HP 86120B are performed in air, the density of air, due to elevation, affects the wavelength results. You must calibrate the HP 86120B by entering the elevation. Elevations from 0 to 5000 meters can be entered. The elevation correction is immediately applied to the current measurement even if the instrument is in the single measurement acquisition mode.

Annotation on the display shows the current calibration elevation in meters and whether the wavelength measurements are shown for a vacuum (VAC) or standard air (STD AIR).

If you select frequency instead of wavelength measurements, switching between vacuum and standard air will not affect the measurement results. This is because the frequency of an optical signal does not change in different mediums—only the wavelength changes.

### **Definition of standard air**

Standard air is defined to have the following characteristics:

Barometric pressure: 760 torr  
Temperature: 15°C  
Relative humidity: 0%

## To enter the elevation

1. Press the Setup key.
2. Press the *MORE* softkey.
3. Press the *CAL* softkey.
4. Press *ELEV*.
5. Use the  $\uparrow$  and  $\downarrow$  softkeys to enter the elevation in meters. Entries jump in 500 meter steps from 0 m to 5000 m.

In order for the HP 86120B to meet its published specifications, the elevation value selected with the softkeys must be within 250 meters of the actual elevation.

6. Press *RETURN* to complete the entry.

### Converting feet to meters

If you know your elevation in feet, you can convert this value to meters by using the following equation:

$$m = \frac{ft}{3.281}$$

---

## To select the medium for light

1. Press the Setup key.
2. Press the *MORE* softkey.
3. Press the *CAL* softkey, and make the following selection:
  - Press *VACUUM* for wavelengths in a vacuum.
  - Press *STD AIR* for wavelengths in standard air.
4. Press *RETURN* to complete the entry.

---

## Printing Measurement Results

Measurement results can be sent directly to a printer. Simply connect a compatible printer to the rear-panel PARALLEL PRINTER PORT connector. The output is ASCII text. An example of a compatible printer is an Hewlett-Packard's LaserJet series printer. Be sure to use a parallel printer cable to connect the printer.

The printer output is not a copy of the display. Rather, it is a listing of all signals present at the input (up to 100). The measurement values printed depend on the settings of the instrument when the Print key is pressed.

The following is an example of a typical printout:

```
HP 86120A SER US36151025
Firmware Ver. 1.000
List By Wavelength
8 Lines
Power Offset 0.0 dB
Vacuum
Elevation 0 Meters
Update Normal
Peak Excursion 15 dB
Peak Threshold 10 dB
```

```
Input
Wavelength  Power
-----
1280.384nm  -16.97dBm
1281.473    -13.14
1282.569    -13.92
1283.651    -13.34
1284.752    -11.69
1285.840     -8.11
1286.944    -10.38
1288.034    -14.65
```

Making Measurements  
**Printing Measurement Results**

---

To create a hardcopy

1. Connect the printer to the HP 86120B's rear-panel PARALLEL PRINTER PORT connector.
2. Press Print.

You can use the *ABORT* and *CONT* softkey to stop and restart a print job that is in progress.

## Cleaning Connections for Accurate Measurements

Accurate and repeatable measurements require clean connections. Use the following guidelines to achieve the best possible performance when making measurements on a fiber-optic system:

- Keep connectors covered when not in use.
- Use dry connections whenever possible.
- Use the cleaning methods described in this section.
- Use care in handling all fiber-optic connectors.
- When inserting a fiber-optic connector into a front-panel adapter, make sure that the fiber end does not touch the outside of the mating connector or adapter.

Because of the small size of cores used in optical fibers, care must be used to ensure good connections. Poor connections result from core misalignment, air gaps, damaged fiber ends, contamination, and improper use and removal of index-matching compounds.

Use dry connections. Dry connectors are easier to clean and to keep clean. Dry connections can be used with physically contacting connectors (for example, Diamond HMS-10/HP, FC/PC, DIN, and ST). If a dry connection has 40 dB return loss or better, making a wet connection will probably not improve (and can degrade) performance.

---

**CAUTION**

Hewlett-Packard strongly recommends that index matching compounds *not* be applied to their instruments and accessories. Some compounds, such as gels, may be difficult to remove and can contain damaging particulates. If you think the use of such compounds is necessary, refer to the compound manufacturer for information on application and cleaning procedures.

---

**Cleaning Connections for Accurate Measurements**

**Table 2-2. Cleaning Accessories**

Item	HP Part Number
Isopropyl alcohol	8500-5344
Cotton swabs	8520-0023
Small foam swabs	9300-1223
Compressed dust remover (non-residue)	8500-5262

**Table 2-3. Dust Caps Provided with Lightwave Instruments**

Item	HP Part Number
Laser shutter cap	08145-64521
FC/PC dust cap	08154-44102
Biconic dust cap	08154-44105
DIN dust cap	5040-9364
HMS10/HP dust cap	5040-9361
ST dust cap	5040-9366

***Inspecting Fiber-Optic Cables***

Consistent measurements with your lightwave equipment are a good indication that you have good connections. However, you may wish to know the insertion loss and/or return loss of your lightwave cables or accessories. If you test your cables and accessories for insertion loss and return loss upon receipt, and retain the measured data for comparison, you will be able to tell in the future if any degradation has occurred.

Connector (or insertion) loss is one important performance characteristic of a lightwave connector. Typical values are less than 0.5 dB of loss, and sometimes as little as 0.1 dB of loss with high performance connectors. Return loss is another important factor. It is a measure of reflection: the less reflection the better (the larger the return loss, the smaller the reflection). The best physically contacting connectors have return losses better than 50 dB, although 30 to 40 dB is more common.

**Visual inspection of fiber ends**

Although it is not necessary, visual inspection of fiber ends can be helpful. Contamination or imperfections on the cable end face can be detected as well as cracks or chips in the fiber itself. Use a microscope (100X to 200X magnification) to inspect the entire end face for contamination, raised metal, or dents in the metal as well as any other imperfections. Inspect the fiber for cracks and chips. Visible imperfections not touching the fiber core may not affect performance (unless the imperfections keep the fibers from contacting).

---

## To clean a non-lensed connector

---

**CAUTION**

---

Do not use any type of foam swab to clean optical fiber ends. Foam swabs can leave filmy deposits on fiber ends that can degrade performance.

1. Apply isopropyl alcohol to a clean lint-free cotton swab or lens paper.

Cotton swabs can be used as long as no cotton fibers remain on the fiber end after cleaning.

2. Before cleaning the fiber end, clean the ferrules and other parts of the connector.
3. Apply isopropyl alcohol to a new clean lint-free cotton swab or lens paper.
4. Clean the fiber end with the swab or lens paper. Move the swab or lens paper back and forth across the fiber end several times.

Some amount of wiping or mild scrubbing of the fiber end can help remove particles when application of alcohol alone will not remove them. This technique can remove or displace particles smaller than one micron.

5. Immediately dry the fiber end with a clean, dry, lint-free cotton swab or lens paper.
6. Blow across the connector end face from a distance of 6 to 8 inches using filtered, dry, compressed air. Aim the compressed air at a shallow angle to the fiber end face.

Nitrogen gas or compressed dust remover can also be used.

## Making Measurements

### Cleaning Connections for Accurate Measurements

---

**CAUTION**

---

Do not shake, tip, or invert compressed air canisters, because this releases particles in the can into the air. Refer to instructions provided on the compressed air canister.

7. As soon as the connector is dry, connect or cover it for later use.

---

### To clean an adapter

1. Apply isopropyl alcohol to a clean foam swab.

Cotton swabs can be used as long as no cotton fibers remain after cleaning. The foam swabs listed in this section's introduction are small enough to fit into adapters.

Although foam swabs can leave filmy deposits, these deposits are very thin, and the risk of other contamination buildup on the inside of adapters greatly outweighs the risk of contamination by foam swabs.

2. Clean the adapter with the foam swab.
3. Dry the inside of the adapter with a clean, dry, foam swab.
4. Blow through the adapter using filtered, dry, compressed air.

Nitrogen gas or compressed dust remover can also be used.

---

**CAUTION**

---

Do not shake, tip, or invert compressed air canisters, because this releases particles in the can into the air. Refer to instructions provided on the compressed air canister.



## To test insertion loss and return loss

To test insertion loss, use an appropriate lightwave source and a compatible lightwave receiver to test insertion loss. Examples of test equipment configurations include the following equipment:

- HP 71450B/51B/52B optical spectrum analyzers with Option 002 built-in white light source.
- HP 8702 or HP 8703 lightwave component analyzer system
- HP 83420 lightwave test set with an HP 8510 network analyzer
- HP 8153 lightwave multimeter with a source and power sensor module

To test return loss, use an appropriate lightwave source, a lightwave receiver, and lightwave coupler to test return loss. Examples of test equipment configurations include the following equipment:

- HP 8703 lightwave component analyzer
- HP 8702 analyzer with the appropriate source, receiver, and lightwave coupler
- HP 8504 precision reflectometer
- HP 8153 lightwave multimeter with a source and power sensor module in conjunction with a lightwave coupler
- HP 81554SM dual source and HP 81534A return loss module

Making Measurements

**Cleaning Connections for Accurate Measurements**

---

Programming

 **Programming**

This chapter explains how to program the HP 86120B. The programming syntax conforms to the IEEE 488.2 Standard Digital Interface for Programmable Instrumentation and to the Standard Commands for Programmable Instruments (SCPI).

***Where to begin...***

- If you are unfamiliar with the rules governing SCPI command syntax, refer to “Reviewing SCPI Syntax Rules” on page 3-25.
- To learn how to correctly begin your programs, refer to “Addressing and Initializing the Instrument” on page 3-4.
- To learn which commands to use and how to use them, refer to “Making Measurements” on page 3-6.
- To learn to read the instrument’s status registers, refer to “Monitoring the Instrument” on page 3-17.

The programming examples for individual commands in this manual are written in HP BASIC 6.0 for an HP 9000 Series 200/300 Controller.

**Contents**

Addressing and Initializing the Instrument 3-4  
    To change the HP-IB address 3-5

Making Measurements 3-6  
    Commands are grouped in subsystems 3-8  
    Measurement instructions give quick results 3-10  
    The format of returned data 3-16

Monitoring the Instrument 3-17  
    Status registers 3-18  
    Queues 3-24

Reviewing SCPI Syntax Rules 3-25

Example Programs 3-31  
    Example 1. Measure a DFB laser 3-34  
    Example 2. Measure a Fabry Perot laser 3-36  
    Example 3. Measure a Fabry Perot laser's drift 3-38  
    Example 4. Measure laser-line separation 3-41  
    Example 5. Measure signal-to-noise ratio 3-44  
    Example 6. Increase a source's wavelength accuracy 3-46

Lists of Commands 3-48

## Addressing and Initializing the Instrument

The HP 86120B's HP-IB address is configured at the factory to a value of 20. You must set the output and input functions of your programming language to send the commands to this address. You can change the HP-IB address from the front panel as described in "To change the HP-IB address" on page 3-5.

### ***Remote mode and front-panel lockout***

Whenever the instrument is controlled by a computer, the Remote message is displayed on the instrument's screen and the softkey menu is blanked except for the *LOCAL* softkey. This softkey can be pressed by the user to restore front panel control of the instrument.

You can specify a local lockout mode that prevents the *LOCAL* softkey from being displayed. If the instrument is in local lockout mode, all the softkeys may be blanked. For example, if the instrument is first placed in local lockout mode and then placed in remote mode, no softkeys are displayed.

Consult the documentation for your programming environment to determine which commands are used to put an instrument in the remote and local lock-out modes. These are not HP 86120B commands; they control HP-IB control lines and do not send any characters to the HP 86120B.

### ***Initialize the instrument at start of every program***

It is good practice to initialize the instrument at the start of every program. This ensures that the bus and all appropriate interfaces are in a known state. HP BASIC provides a CLEAR command which clears the interface buffer and also resets the instrument's parser. (The parser is the program that reads the instructions that you send.) Whenever the instrument is under remote programming control, it should be in the single measurement acquisition mode. This is automatically accomplished when the \*RST common command is used. The \*RST command initializes the instrument to a preset state:

```
CLEAR 720  
OUTPUT 720; "*"RST"
```

Notice in the example above, that the commands are sent to an instrument address of 720. This indicates address 20 on an interface with select code 7. Pressing the green Preset key does not change the HP-IB address.

#### ***Set single acquisition mode***



An advantage of using the \*RST command is that it sets the HP 86120B into the single measurement acquisition mode. Because the READ and MEASure data queries expect this mode, their proper operation is ensured.

#### ***Establish the wavelength range***

At the start of each program, be sure to establish the input wavelength range using the HP 86120B's :CALCulate2:WLMit command. Setting this command to off enables the full wavelength range of the instrument. If you are measuring signals over a narrow wavelength range, use this command to ensure that spurious second harmonic peaks are not identified. Refer to "WLMit[:STATe]" on page 4-37, "WLMit:START" on page 4-38 and "WLMit:STOP" on page 4-41. Refer also to "To limit the wavelength range" on page 2-10.

---

## To change the HP-IB address

1. Press the Setup key.
2. Press *MORE* twice, then *HP-IB*.
3. Use the  and  softkeys to change the HP-IB address.
4. Press *RETURN*.

---

## Making Measurements

Making measurements remotely involves changing the HP 86120B's settings, performing a measurement, and then returning the data to the computer. The simplified block diagram of the HP 86120B shown here lists some of the available programming commands. Each command is placed next to the instrument section it configures or queries data from.

Notice that there are two buffers from which data can be queried: an uncorrected data buffer and a corrected data buffer. With each scan of the input wavelength range, the analog-to-digital converter loads 65,536 data values into the uncorrected data buffer. This is considered to be one "measurement". A fast-update measurement mode is available for quicker measurement acquisi-

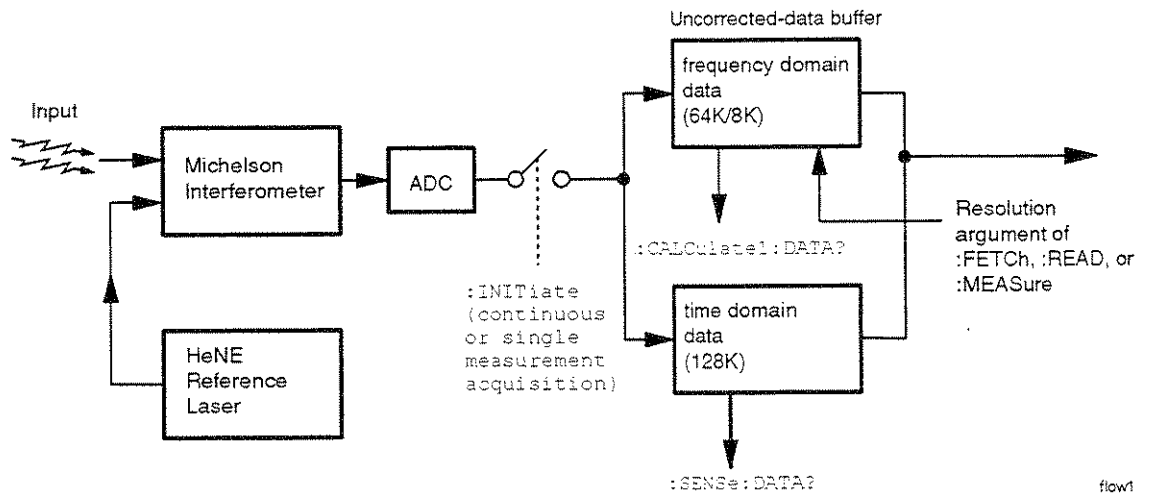



tion. But, because only 8,192 data values are collected in fast-update measurement mode, the ability to resolve closely spaced signals is reduced.

After collecting the uncorrected data, the HP 86120B searches the data for the first 100 peak responses. (Searching starts at 1700 nm and progresses towards 700 nm for WLIMit OFF. If WLIMit is on, searching starts at WLIMit:START to WLIMit:STOP). These peak values are then placed into the corrected data buffer. Each peak value consists of an amplitude and wavelength measurement. Amplitude and wavelength correction factors are applied to this data.

For a listing of the programming commands (including a cross reference to front-panel keys), refer to the following tables:

Table 3-7, "Programming Commands," on page 3-48

Table 3-8, "Keys Versus Commands," on page 3-54

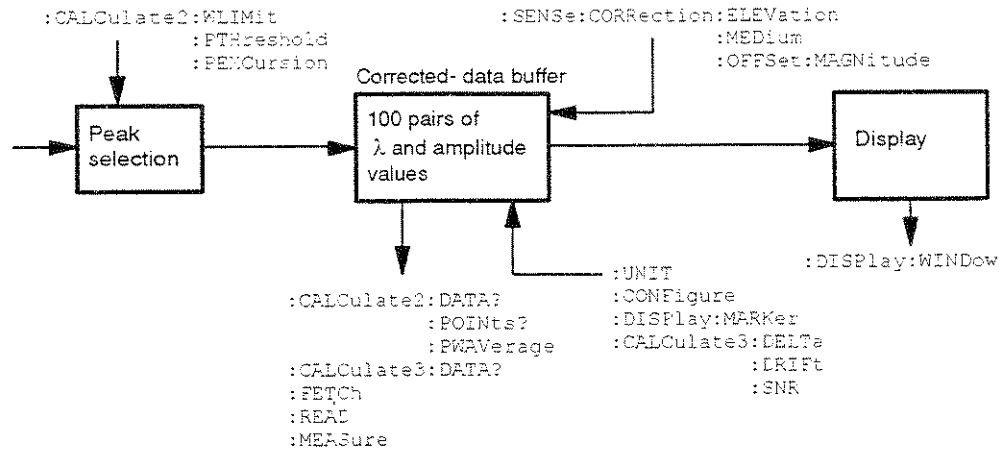

flow2

## Commands are grouped in subsystems

The HP 86120B commands are grouped in the following subsystems. You'll find a description of each command in Chapter 4, "Programming Commands".

<u>Subsystem</u>	<u>Purpose of Commands</u>
Measurement Instructions	Perform frequency, wavelength, wavenumber, and coherence length measurements.
CALCulate1	Queries <i>uncorrected</i> frequency-spectrum data.
CALCulate2	Queries <i>corrected</i> peak data and sets wavelength limits..
CALCulate3	Performs delta, drift, and signal-to-noise measurements.
DISPlay	Applies markers and displays power bars.
HCOPy	Prints measurement results.
SENSe	Sets elevation-correction values, selects readings for air or vacuum, and enters amplitude offsets. Queries time-domain values of the input data.
STATus	Queries instrument status registers.
SYSTem	Presets HP 86120B and queries error messages.
TRIGger	Stops current measurement. Acquires new measurement data. Also used to select single or continuous acquisition of measurement data.
UNIT	Sets the amplitude units to watts or dBm.

Table 3-1 on page 3-9 shows the kinds of measurements that the HP 86120B can perform and the associated programming commands used to return that data. In some cases, there is more than one method that can be used to obtain the desired data. Refer to Chapter 4, "Programming Commands" for the correct syntax for these commands.

**Table 3-1. Commands for Capturing Data**

<b>Desired Measurement</b>	<b>Command to Configure Measurement (partial listing)</b>	<b>Command to Query Data</b>
Wavelength (nm)	CONFigure, FETCh, READ, and MEASure	MEASure:ARRay:POWer:WAVelength?
Frequency (THz)	CONFigure, FETCh, READ, and MEASure	MEASure:ARRay:POWer:FREQuency?
Wavenumber ( $m^{-1}$ )	CONFigure, FETCh, READ, and MEASure	MEASure:ARRay:POWer:WNUMber?
Coherence Length (m)	CONFigure, FETCh, READ, and MEASure	FETCh, READ, or MEASure
Power (W, dBm)	CONFigure, FETCh, READ, and MEASure	MEASure:ARRay:POWer?
Average Wavelength, Wavenumber, or Frequency	CALCulate2:PWAVerage:STATe	CALCulate2:DATA?
Total Power (W, dBm)	CALCulate2:PWAVerage:STATe	CALCulate2:DATA?
Laser-Line Separation	CALCulate3:DELta:REFerence	CALCulate3:DATA?
Laser-Line Drift	CALCulate3:DRIFt:STATe	CALCulate3:DATA?
Signal-to-Noise Ratio	CALCulate3:SNR:STATe	CALCulate3:DATA?
Signal-to-Noise Ratio Average	CALCulate3:ASNR:STATe	CALCulate3:DATA?
Time-Domain Data	CALCulate1:TRANSform:FREQuency:POINts	SENSe:DATA?
Corrected Frequency Domain Data	CALCulate1:TRANSform:FREQuency:POINts	CALCulate2:DATA?
Uncorrected Frequency Domain Data	CALCulate1:TRANSform:FREQuency:POINts	CALCulate1:DATA?

## Measurement instructions give quick results

The easiest way to measure wavelength, frequency, power, or coherence length is to use the MEASure command. The MEASure command is one of four measurement instructions: MEASure, READ, FETCh, and CONFIgure. The syntax for measurement instructions is documented in "Measurement Instructions" on page 4-16.

Each measurement instruction has an argument that controls the measurement update rate. This is equivalent to using the *NORMAL* and *FAST* softkeys.

### **:MEASure command**

MEASure configures the HP 86120B, captures new data, and queries the data all in one step. For example, to measure the longest wavelength, send the following command:

```
:MEASure:SCALar:POWer:WAVelength? MAX
```

**Table 3-2. The Different Forms of MEASure**

Desired Measurement Data	Use this MEASure Query	Display Format
Power (W, dBm)	:MEASure:ARRay:POWer?	List by Power
	:MEASure:SCALar:POWer?	single wavelength mode
Frequency (Hz)	:MEASure:ARRay:POWer:FREQuency?	List by WL ( <i>frequency</i> )
	:MEASure:SCALar:POWer:FREQuency?	single wavelength mode
Wavelength (m)	MEASure:ARRay:POWer:WAVelength?	List by WL
	MEASure:SCALar:POWer:WAVelength?	single wavelength mode
Wavenumber (m <sup>-1</sup> )	:MEASure:ARRay:POWer:WNUMber?	List by WL
	:MEASure:SCALar:POWer:WNUMber?	single wavelength mode
Coherence Length (m)	:MEASure:LENGth:COHerence?	coherence length

Specifying SCALAr places the display in the single wavelength format and returns a single value to the computer. Specifying ARRAy places the display in the List by Power or List by WL modes; an array of data is returned to the computer.

A common programming error is to send the :MEASure command when the instrument is in the continuous measurement acquisition mode. Because :MEASure contains an :INIT:IMM command, which expects the single measurement acquisition mode, an error is generated, and the INIT command is ignored.

***:READ command***

The READ command works like the MEASure command except that it does not configure the instrument's settings. You can use the CONFIgure command to configure the instrument for a particular measurement without returning any data.

The MEASure and READ commands are identical to combining the following commands:

<u>Command</u>	<u>Equivalent Commands</u>
:MEASure	:ABORt;:CONFIgure;:READ
:READ	:ABORt;:INITiate:IMMEDIATE;:FETCh

A common programming error is to send the :READ command when the instrument is in the continuous measurement acquisition mode. Because :READ contains an :INIT:IMM command, which expects the single measurement acquisition mode, an error is generated, and the INIT command is ignored.

***:FETCh command***

The FETCh command returns data from previously performed measurements; it does not initiate the collection of new data. Because FETCh does not configure the instrument or acquire new input data, you can use FETCh repeatedly on the same set of acquired data. For example, use two FETCh commands to return wavelength and then power values for the same measurement. This is shown in the following program fragment:

```
OUTPUT 720; ":INIT:CONT OFF;"
OUTPUT 720; ":CONF:ARR:POW MAX"
OUTPUT 720; ":INIT:IMM"
OUTPUT 720; ":FETC:ARR:POW?"
ENTER 720:powers$
OUTPUT 720; ":FETC:ARR:POW:WAV?"
ENTER 720:wavelengths$
```

## Programming

### Making Measurements

In the example above, the data in the power and wavelength arrays are returned in the same order so that powers can be matched to wavelengths.

Also, because new data is not collected, FETCh is especially useful when characterizing transient data.

FETCh does not reconfigure the display. For example, if the display is in the Peak WL mode, sending :FETCh:ARRay does not configure the display to the List by WL even though an array of data is returned to the computer.

A common programming error occurs when the :FETCh command is used after an \*RST command. This generates error number -230, "Data corrupt or stale". In this instance, you must send :INIT:IMM after the \*RST command and before :FETCh command to capture a new array of measurement data.

#### **:CONFigure command**

The CONFigure command changes measurement settings without taking a measurement. The instrument is placed in the List by WL, List by Ampl, Peak WL display, or in the coherence length application.

CONFigure can be queried. The query returns the last configuration setup by the CONFigure command. The instrument returns a string which is the last instrument function sent by a CONFigure command or MEASure query. The returned string is in the short command form. Use caution when using this query, because if any instrument settings were changed since the last CONFigure command or MEASure query these changes may not be included in the returned string.

For example, if the last CONFigure command was

```
:CONFigure:SCALar:POWer:WAVelength 1300NM, MAX
```

a CONFigure? query would return a string that is similar to the following line:

```
"POW:WAV 1.300000e-6,0.01"
```

The *1300NM* and *resolution* values track the actual instrument settings and input signals. Notice that the quotation marks are part of the returned string.

#### **Return single or multiple measurement values**

You can specify whether FETCh, READ, or MEASure returns a single value (SCALar) or multiple values (ARRay). The following example specifies SCALar data which returns a single value.

```
:MEASure:SCALar:POWer:WAVelength? MAX
```

#### **ARRay and the SCPI standard**

According to the SCPI command reference, ARRay command causes an instrument to take multiple measurements. (A <size> parameter indicates the number of measurements to take.) However, the HP 86120A's ARRay command refers to the measurements performed for one measurement sweep; this results in an array of measured signals. Because the <size> parameter does not apply, any <size> parameter sent will be ignored by the instrument. No syntax error will be generated if a <size> parameter is sent.

#### ***Always force the HP 86120B to wait for non-sequential commands***

The HP 86120B normally processes its remote programming commands sequentially. The instrument waits until the actions specified by a particular command are completely finished before reading and executing the next command. However, there are a few non-sequential commands where this is not true. Non-sequential commands do *not* finish executing before the next command is interpreted.

The following is a list of the HP 86120B's non-sequential commands:

```
:CALCulate1:TRANSform:FREQuency:POINTs  
:CALCulate2:PEXCursion  
:CALCulate2:PTHreshold  
:CALCulate2:WLIMit:STATe  
:CALCulate2:WLIMit:START:FREQuency  
:CALCulate2:WLIMit:START:WAVelength  
:CALCulate2:WLIMit:START:WNUMBER  
:CALCulate2:WLIMit:STOP:FREQuency  
:CALCulate2:WLIMit:STOP:WAVelength  
:CALCulate2:WLIMit:STOP:WNUMBER  
:CALCulate3:SNR:AUTO  
:SENSe:CORRection:ELEVation  
:INITiate:CONTinuous  
:INITiate[:IMMediate]
```

The following additional commands are also non-sequential commands if CALCulate3:SNR:AUTO is set to OFF:

```
:CALCulate3:REFerence:FREQuency  
:CALCulate3:REFerence:WAVelength  
:CALCulate3:REFerence:WNUMBER
```

## Programming

### Making Measurements

The benefit of non-sequential commands is that, in some situations, they can reduce the overall execution times of programs. For example, you can set the peak excursion, peak threshold, and elevation and use a \*WAI command at the end to save time. However, non-sequential commands can also be a source of annoying errors. Always use the \*OPC query or \*WAI command with the non-sequential commands to ensure that your programs execute properly.

For example, suppose that you wanted to set the elevation correction value and then send an :INIT:IMM command. The following programming fragment results in an error -213 *"Init ignored"*. This occurs because the :ELEVation command causes the recalculation of the data which is like sending the :INIT:IMM command. When the actual :INIT:IMM is sent, the error occurs because the command is already in progress.

```
OUTPUT 720; ":INIT:IMM"  
OUTPUT 720; ":SENSe:CORRection:ELEVation 1000"  
OUTPUT 720; ":INIT:IMM"
```

Use an \*OPC? query to ensure that the :ELEVation command has completed as shown in the following lines:

```
OUTPUT 720; ":INIT:IMM"  
OUTPUT 720; ":SENSe:CORRection:ELEVation 1000"  
OUTPUT 720; "*OPC?"  
ENTER 720;Response$  
OUTPUT 720; ":INIT:IMM"
```

Or, the \*WAI command could be used:

```
OUTPUT 720; ":INIT:IMM"  
OUTPUT 720; ":SENSe:CORRection:ELEVation 1000"  
OUTPUT 720; "*WAI?"  
OUTPUT 720; ":INIT:IMM"
```



## Measure delta, drift, and signal-to-noise

To select a measurement, use one of the following STATE commands:

CALC3:DELT:POW:STAT (*delta power*)  
CALC3:DELT:WAV:STAT (*delta wavelength*)  
CALC3:DELT:WPOW:STAT (*delta power and wavelength*)  
CALC3:DRIF:STAT (*drift*)  
CALC3:SNR:STAT (*signal-to-noise ratios*)  
CALC3:ASNR:STAT (*signal-to-noise ratio averaging*)

If you select a drift measurement, you can additionally select one of the following additional states:

CALC3:DRIF:DIFF:STAT (*difference*)  
CALC3:DRIF:MAX:STAT (*maximum drift*)  
CALC3:DRIF:MIN:STAT (*minimum drift*)  
CALC3:DRIF:REF:STAT (*drift reference values*)

The :CALCulate3:DRIFt:PRESet command turns off the minimum, maximum, difference, and reference states but leaves the drift state on.

Attempting to turn more than one state on at a time results in a “-221 Settings Conflict” error.

The \*RST and SYSTEM:PRESet commands turn all calculations off.

CALCulate3:PRESet turns off any CALCulate3 calculations.

## The format of returned data

### ***Measurements are returned as strings***

All measurement values are returned from the HP 86120B as ASCII strings. When an array is returned, the individual values are separated by the comma character.

### ***Determine the number of data points***

When a FETCh, READ, or MEASure command is used (with ARRay specified), the first returned value indicates the total number of measurement values returned in the query.

If you use the :CALCulate1:DATA?, :CALCulate2:DATA?, or :CALCulate3:DATA? queries to query data, send the :POINTs? query first to determine the number of values returned in the string. The string does not contain a first value which specifies the string length. This is shown in the following example:

```
OUTPUT 720; ":CALCulate1:POINTs?"  
ENTER 720;Length  
OUTPUT 720; ":CALCulate1:DATA?"  
ENTER 720;Results
```

### ***Data can be corrected for elevation and vacuum***

Normally, the HP 86120B provides measurement values calculated for conditions in air at sea level. Use the :SENSE:CORREction:ELEVation command to compensate for air dispersion. Altitudes up to 5000 meters can be entered. Use the :SENSE:CORREction:MEDium command to switch to readings in a vacuum.

### ***Amplitude units***

The default amplitude units are dBm. If you need measurements in watts, use the :UNIT:POWer command. When the HP 86120B is turned on, the amplitude units are automatically set to the units used before the instrument was last turned off.

---

## Monitoring the Instrument

Almost every program that you write will need to monitor the HP 86120B for its operating status. This includes querying execution or command errors and determining whether or not measurements have been completed. Several status registers and queues are provided to accomplish these tasks.

In this section, you'll learn how to enable and read these registers. In addition to the information in this section, you should review the commands documented in "Common Commands" on page 4-4 and "STATUS Subsystem" on page 4-82.

## Status registers

The HP 86120B provides four registers which you can query to monitor the instrument's condition. These registers allow you to determine the following items:

- Status of an operation
- Availability of the measured data
- Reliability of the measured data

All three registers are shown in the figure on the following page and have the following uses:

<u>Register</u>	<u>Definition</u>
Status Byte	Monitors the status of the other three registers.
Standard Event Status	This is the standard IEEE 488.2 register. Contains bits which indicate the status of the other two registers.
OPERation Status	Contains bits that report on the instrument's normal operation.
QUESTionable Status	Contains bits that report on the condition of the signal.

### ***Status Byte register***

The Status Byte Register contains summary bits that monitor activity in the other status registers and queues. The Status Byte Register's bits are set and cleared by the presence and absence of a summary bit from other registers or queues. Notice in the following figure that the bits in the Standard Event Status, OPERation status, and QUESTionable status registers are "or'd" to control a bit in the Status Byte Register.

If a bit in the Status Byte Register goes high, you can query the value of the source register to determine the cause.

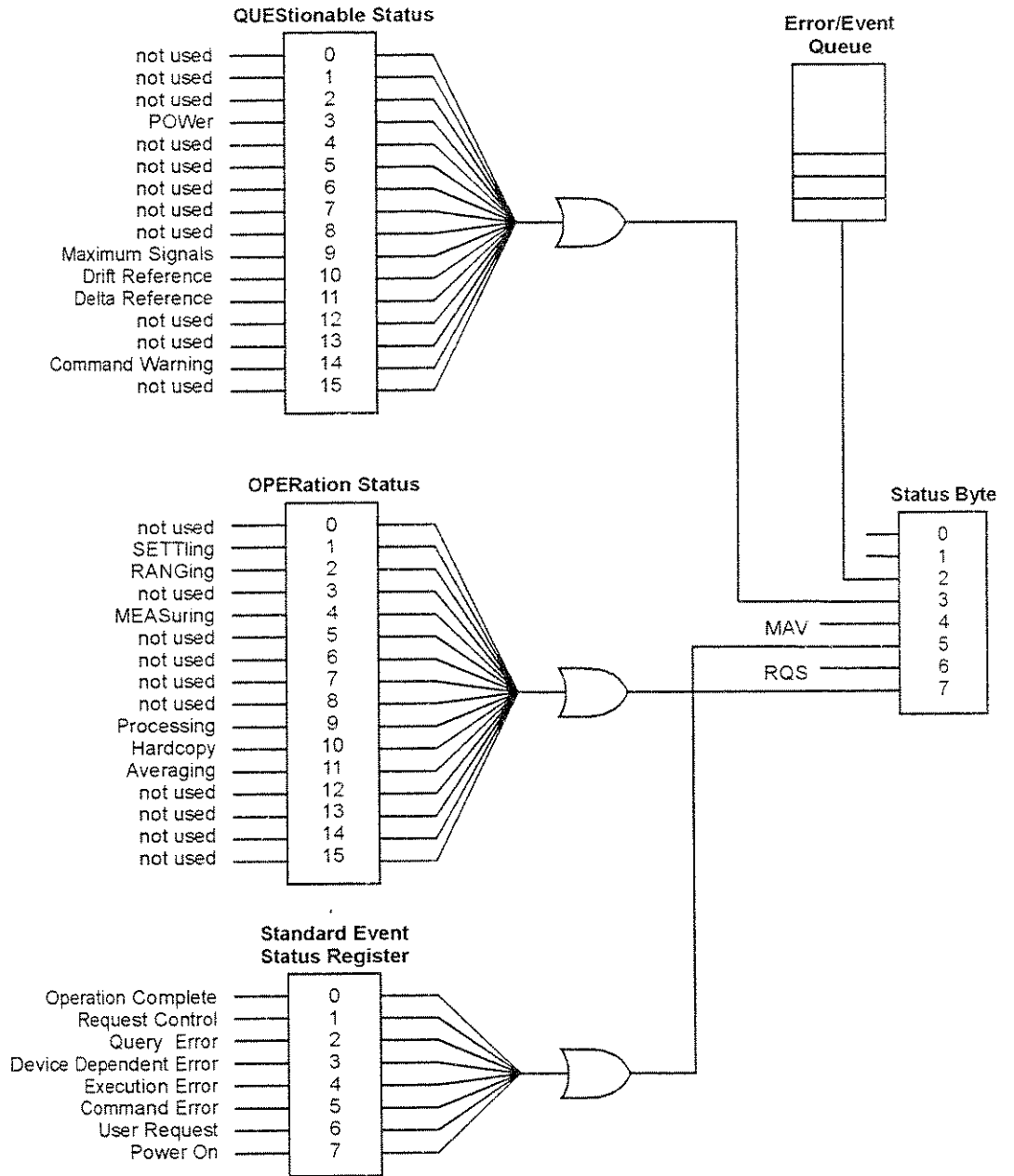

status

### **Monitoring the Instrument**

The Status Byte Register can be read using either the \*STB? common command or the HP-IB serial poll command. Both commands return the decimal-weighted sum of all set bits in the register. The difference between the two methods is that the serial poll command reads bit 6 as the Request Service (RQS) bit and clears the bit which clears the SRQ interrupt. The \*STB? command reads bit 6 as the Master Summary Status (MSS) and does not clear the bit or have any effect on the SRQ interrupt. The value returned is the total bit weights of all of the bits that are set at the present time.

#### ***OPERation Status and QUEStionable Status registers***

You can query the value of the OPERation Status and QUEStionable Status registers using commands in the STATus subsystem.

The STATus subsystem also has transition filter software which give you the ability to select the logic transitions which set bits in the OPERation Status and QUEStionable Status registers. For example, you can define the POWER bit of the QUEStionable Status register to report an event when the condition transitions from false to true. This is a positive transition. You can also specify a negative transition where the bit is set when the condition transitions from true to false.

**Table 3-3. Bits in Operation Status Register**

Bit	Definition
0	<i>not used</i>
1	<i>SETTling</i> - indicating that the instrument is waiting for the motor to reach the proper position before beginning data acquisition.
2	<i>RANGing</i> - indicating the the instrument is currently gain ranging.
3	<i>not used</i>
4	<i>MEASuring</i> - indicating that the instrument is making a measurement.
5 through 8	<i>not used</i>
9	<i>Processing</i> - indicating that the instrument is currently processing the data acquired.
10	<i>Hardcopy</i> - indicating that the instrument is currently printing the data to the parallel port.
11	<i>Averaging</i> - indicating that the instrument is in the process of averaging the noise for the signal-to-noise ratio calculation.
12 through 16	<i>not used</i>

**Monitoring the Instrument****Table 3-4. Bits in Questionable Status Register**

<b>Bit</b>	<b>Definition</b>
0, 1, and 2	<i>not used</i>
3	<i>POWer</i> - indicating that the instrument is measuring too high of a power.
3 through 8	<i>not used</i>
9	<i>Maximum signals</i> - indicating that the instrument has found the maximum number of signals.
10	<i>Drift Reference</i> - indicating that the number of reference signals is different from the current number of input signals.
11	<i>Delta Reference</i> - indicating that there is no delta reference signal.
12 through 13	<i>not used</i>
14	<i>Command Warning</i> - indicating that the instrument has received some extra unexpected parameters for one of the measurement functions.
15	<i>not used</i>

**Standard Event Status register**

The Standard Event Status Register monitors the following instrument status events:

- OPC - Operation Complete
- RQC - Request Control
- QYE - Query Error
- DDE - Device Dependent Error
- EXE - Execution Error
- CME - Command Error
- URQ - User Request
- PON - Power On

When one of these events occur, the event sets the corresponding bit in the register. If the bits are enabled in the Standard Event Status Enable Register, the bits set in this register generate a summary bit to set bit 5 (ESB) in the Status Byte Register.

The contents of the Standard Event Status Register can be read and the register cleared by sending the \*ESR? query. The value returned is the total bit weights of all of the bits that are set at the present time.



***Enabling register bits with masks***

Several masks are available which you can use to enable or disable individual bits in each register. For example, you can disable the Hardcopy bit in the OPERation Status Register so that even though it goes high, it can never set the summary bit in the status byte high.

Use the \*SRE common command to set or query the mask for the Status Byte Register.

The masks for the OPERation Status and QUEStionable Status registers are set and queried using the STATus subsystem's ENABle commands.

Use the \*ESE common command to set or query the mask for the Standard Event Status Register.

The \*CLS common command clears all event registers and all queues except the output queue. If \*CLS is sent immediately following a program message terminator, the output queue is also cleared. In addition, the request for the \*OPC bit is also cleared.

For example, suppose your application requires an interrupt whenever any type of error occurs. The error related bits in the Standard Event Status Register are bits 2 through 5. The sum of the decimal weights of these bits is 60. Therefore, you can enable any of these bits to generate the summary bit by sending the \*ESE 60 command.

Whenever an error occurs, it sets one of these bits in the Standard Event Status Register. Because the bits are all enabled, a summary bit is generated to set bit 5 in the Status Byte Register.

If bit 5 (ESB) in the Status Byte Register is enabled (via the \*SRE command), an SRQ service request interrupt is sent to the external computer.

Standard Event Status Register bits that are not enabled still respond to their corresponding conditions (that is, they are set if the corresponding event occurs). However, because they are not enabled, they do not generate a summary bit to the Status Byte Register.

## Queues

There are two queues in the instrument: the output queue and the error queue. The values in the output queue and the error queue can be queried.

### *Output queue*

The output queue stores the instrument responses that are generated by certain commands and queries that you send to the instrument. The output queue generates the Message Available summary bit when the output queue contains one or more bytes. This summary bit sets the MAV bit (bit 4) in the Status Byte Register. The method used to read the Output Queue depends upon the programming language and environment. For example, with HP Basic, the output queue may be read using the ENTER statement.

### *Error queue*

As errors are detected, they are placed in an error queue. Instrument specific errors are indicated by positive values. General errors have negative values. You can clear the error queue by reading its contents, sending the \*CLS command, or by cycling the instrument's power.

The error queue is first in, first out. If the error queue overflows, the last error in the queue is replaced with error -350, "Queue overflow." Any time the queue overflows, the least recent errors remain in the queue, and the most recent error is discarded. The length of the instrument's error queue is 30 (29 positions for the error messages, and 1 position for the "Queue overflow" message).

The error queue is read with the SYSTEM:ERROR? query. Executing this query reads and removes the oldest error from the head of the queue, which opens a position at the tail of the queue for a new error. When all the errors have been read from the queue, subsequent error queries return 0, "No error."

For more information on reading the error queue, refer to "ERRor" on page 4-90. For a list of errors messages, refer to "Error Messages" on page 7-12.

---

## Reviewing SCPI Syntax Rules

The HP 86120B's programming commands comply with the SCPI standard. In this section, you'll learn the correct syntax for forming and sending HP 86120B command strings. For more detailed information regarding the HP-IB, the IEEE 488.2 standard, or the SCPI standard, refer to the following books:

Hewlett-Packard Company. *Tutorial Description of Hewlett-Packard Interface Bus*, 1987.

Hewlett-Packard Company. *SCPI—Standard Commands for Programmable Instruments*, 1995.

International Institute of Electrical and Electronics Engineers. *IEEE Standard 488.1-1987, IEEE Standard Digital Interface for Programmable Instrumentation*. New York, NY, 1987.

International Institute of Electrical and Electronics Engineers. *IEEE Standard 488.2-1987, IEEE Standard Codes, Formats, Protocols and Common commands For Use with ANSI/IEEE Std 488.1-1987*. New York, NY, 1987.

### **Types of commands**

The HP 86120B responds to three types of commands:

- Common commands
- Measurement instructions
- Subsystem commands

All of these commands are documented in Chapter 4, "Programming Commands". The common commands are defined by IEEE 488.2. These commands control some functions that are common to all IEEE 488.2 instruments. Common command headers consist of only a single mnemonic preceded by an asterisk. The standard SCPI commands are the commands required for compatibility with SCPI. Measurement instructions are those commands which are specific to the control of the instrument. Measurement instructions are compound headers consisting of two or more mnemonics.

## Reviewing SCPI Syntax Rules

### *SCPI command are grouped in subsystems*

In accordance with IEEE 488.2, the instrument's commands are grouped into "subsystems." Commands in each subsystem perform similar tasks. The following subsystems are provided:

- Measurement Instructions
- Calculate1 Subsystem
- Calculate2 Subsystem
- Calculate3 Subsystem
- Display Subsystem
- Hcopy Subsystem
- Sense Subsystem
- Status Subsystem
- System Subsystem
- Trigger Subsystem
- Unit Subsystem

### *Sending a command*

It's easy to send a command to the instrument. Simply create a command string from the commands listed in this book, and place the string in your program language's output statement. For commands other than common commands, include a colon before the subsystem name. For example, the following string places the cursor on the peak laser line and returns the power level of this peak:

```
OUTPUT 720; ":MEAS:SCAL:POW? MAX"
```

### *Use either short or long forms*

Commands and queries may be sent in either long form (complete spelling) or short form (abbreviated spelling). The description of each command in this manual shows both versions; the extra characters for the long form are shown in lowercase. The following is a long form of a command:

```
OUTPUT 720; ":MEASure:SCALar:POWer? MAXimum"
```

And this is the short form of the same command:

```
OUTPUT 720; ":MEAS:SCAL:POW? MAX"
```

Programs written in long form are easily read and are almost self-documenting. Using short form commands conserves the amount of controller memory needed for program storage and reduces the amount of I/O activity.

The rules for creating short forms from the long form is as follows:

*The mnemonic is the first four characters of the keyword unless the fourth character is a vowel, in which case the mnemonic is the first three characters of the keyword.*

This rule is *not* used if the length of the keyword is exactly four characters.

**Table 3-5. Examples of Short Forms**

Long Form	Equivalent Short Form
ROUTE	ROUT
LAYER	LAY
SYSTEM	SYST
ERROR	ERR

***You can use upper or lowercase letters***

Program headers can be sent using any combination of uppercase or lowercase ASCII characters. Instrument responses, however, are always returned in uppercase.

***Combine commands in the same subsystem***

You can combine commands from the same subsystem provided that they are both on the same level in the subsystem's hierarchy. Simply separate the commands with a semi-colon (;). For example, the following two lines,

```
OUTPUT 720;":CALC2:PEXC 12"
OUTPUT 720;":CALC2:PTHR 20"
```

can be combined into one line:

```
OUTPUT 720;":CALC2:PEXC 12;PTHR 20"
```

The semicolon separates the two functions.

***Combine commands from different subsystems***

You can send commands and program queries from different subsystems on the same line. Simply precede the new subsystem by a semicolon followed by a colon. In the following example, the colon and semicolon pair before DISP allows you to send a command from another subsystem.

```
OUTPUT 720;":CALC2:PEXC 12;:DISP:WIND:GRAP:STAT OFF"
```

## Reviewing SCPI Syntax Rules

### *Sending common commands*

If a subsystem has been selected and a common command is received by the instrument, the instrument remains in the selected subsystem. For example, if the program message

```
"DISPLAY:MARK:MAX:LEFT;*CLS;DISP:MARK:MAX:RIGH"
```

is received by the instrument, the Display subsystem remains selected.

If some other type of command is received within a program message, you must reenter the original subsystem after the command.

### *Adding parameters to a command*

Many commands have parameters that specify an option. Use a space character to separate the parameter from the command as shown in the following line:

```
OUTPUT 720;" : INIT:CONT ON"
```

Separate multiple parameters with a comma (,). Spaces can be added around the commas to improve readability.

```
OUTPUT 720;" : MEAS:SCAL:POW:FREQ? 1300, MAX"
```

### *White space*

White space is defined to be one or more characters from the ASCII set of 0 through 32 decimal, excluding 10 (NL). White space is usually optional, and can be used to increase the readability of a program.

### *Numbers*

All numbers are expected to be strings of ASCII characters. Thus, when sending the number 9, you would send a byte representing the ASCII code for the character "9" (which is 57). A three-digit number like 102 would take up three bytes (ASCII codes 49, 48, and 50). This is taken care of automatically when you include the entire instruction in a string. Several representations of a number are possible. For example, the following numbers are all equal:

```
28  
0.28E2  
280E-1  
28000m  
0.028K  
28E-3K
```

If a measurement cannot be made, no response is given and an error is placed into the error queue. For example,

```
*RST
FETCh:POW?
```

will timeout the controller and place a *Data stale or corrupt* error into the error queue.

**Table 3-6. Suffix Multipliers**

Multiplier	Mnemonic
1E18	EX
1E15	PE
1E12	T
1E9	G
1E6	MA
1E3	K
1E-3	M
1E-6	U
1E-9	N
1E-12	P
1E-15	F
1E-18	A

***Program message terminator***

The string of instructions sent to the instrument are executed after the instruction terminator is received. The terminator may be either a new-line (NL) character, the End-Of-Identify (EOI) line asserted, or a combination of the two. All three ways are equivalent. Asserting the EOI sets the EOI control line low on the last byte of the data message. The NL character is an ASCII linefeed (decimal 10). The NL terminator has the same function as an EOS (End Of String) and EOT (End Of Text) terminator.

***Querying data***

Data is requested from the instrument using a query. Queries can be used to find out how the instrument is currently configured. They are also used to get results of measurements made by the instrument, with the query actually activating the measurement. String responses are returned as upper-case letters.

Queries usually take the form of a command followed by a question mark (?). After receiving a query, the instrument places the answer in its output queue. The answer remains in the output queue until it is read or another command is issued. For example, the query

```
OUTPUT 720;":CALCULATE2:POINTS?"
```

places the number of points in the data set in the output queue. In HP BASIC, the controller input statement:

```
ENTER 720;Range
```

passes the value across the bus to the controller and places it in the variable Range. A newline character is appended to the response.

Sending another command or query before reading the result of a query causes the output queue to be cleared and the current response to be lost. This also generates an error in the error queue.

The output of the instrument may be numeric or character data depending on what is queried. Refer to the specific commands for the formats and types of data returned from queries.

You can send multiple queries to the instrument within a single program message, but you must also read them back within a single program message. This can be accomplished by either reading them back into a string variable or into multiple numeric variables. When you read the result of multiple queries into string variables, each response is separated by a semicolon.



---

## Example Programs

The following example programs are provided in this section:

- Example 1. Measure a DFB laser 3-34
- Example 2. Measure a Fabry Perot laser 3-36
- Example 3. Measure a Fabry Perot laser's drift 3-38
- Example 4. Measure laser-line separation 3-41
- Example 5. Measure signal-to-noise ratio 3-44
- Example 6. Increase a source's wavelength accuracy 3-46

These programs are provided to give you examples of using HP 86120B remote programming commands in typical applications. They are not meant to teach general programming techniques or provide ready-to-use solutions. They should allow you to see how measurements are performed and how to return data to the computer.

All of the examples are written in the HP BASIC programming language.

## Example Programs

### ***Many subroutines are repeated in the examples***

The first five example programs contain several common subroutines. These routines, along with one function, are described in the rest of this introduction. The descriptions are listed in the general order that the subroutines are called in the programs.

### ***Error\_msg subroutine***

This function is found in examples 2, 3, 4, and 5. It displays an error message on the computer's screen explaining the reason that the program's execution stopped.

### ***Set\_ese subroutine***

The subroutine sets the enable mask for the event status register to a value of 52. This allows bits 2, 4, and 5 to be set whenever a query error (QYE), execution error (EXE), or command error (CME) respectively occurs. All this is accomplished using the \*ESE common command.

The Err\_mngmt subroutine is used to actually read the value of the event status register. Examples 1 through 5 call this subroutine.

### ***FNIdentity function***

When this function is called, it resets the instrument and queries the instrument's identification string which is displayed on the the computer's screen by the calling function. To accomplish this task, the FNIdentity function uses the \*RST, \*OPC?, and \*IDN? common commands. This function is called from examples 1 through 5.

### ***Err\_mngmt subroutine***

This subroutine checks to make sure that no errors have set bits in the event status register and that there are no errors in the queue. Exiting this subroutine is only possible if no errors have occurred. Notice that the logic test in the subroutine tests for the same event status register bits enabled by the Set\_ese subroutine: BIT(Cme,5), BIT(Cme,4), BIT(Cme,2).

This subroutine is called in examples 1 through 5. However, it is modified in examples 3, 4, and 5 to allow it to indicate the last programming command that was sent to the instrument before an error occurred. This is accomplished by adding an optional argument string.

***Cmd\_opc subroutine***

The Cmd\_opc subroutine, found in examples 3, 4, and 5, pauses the program until a non-sequential command has finished executing on the HP 86120B. It uses the \*OPC? query.

For more information on non-sequential commands, refer to “Always force the HP 86120B to wait for non-sequential commands” on page 3-13.

***Tempo subroutine***

This subroutine, which is only found in example 3, pauses the program for a few seconds while the HP 86120B measures the drift on a laser. The argument in the example sets the pause for 10 seconds.

## Example Programs

---

### Example 1. Measure a DFB laser

This program measures the power and wavelength of a DFB laser. It first sets the HP 86120B in the single-acquisition measurement mode. Then, it triggers the HP 86120B with the MEASure command to capture measurement data of the input spectrum. Because the data is stored in the instrument's memory, it can be queried as needed.

Refer to the introduction to this section for a description of each subroutine that is contained in this program.

```

COM /Instrument/ @Mwm
ASSIGN @Mwm TO 720

Set_ese
PRINT USING "37A,33A";"Multi-Wavelength Meter Identity is :
";FNIdentity$
OUTPUT @Mwm;" :INIT:CONT OFF"
ON TIMEOUT 7,5 CALL Err_mngmt
OUTPUT @Mwm;" :MEAS:SCAL:POW:WAV?"
ENTER @Mwm;Current_wl
OUTPUT @Mwm;" :FETC:SCAL:POW?"
ENTER @Mwm;Current_pwr
OFF TIMEOUT
PRINT USING "20A,4D.3D,3A,19A,M2D.2D,4A";"The wavelength is :
";Current_wl /1.0E-9;" nm";" with a power of : ";Current_pwr;"
dBm"
END

Err_mngmt:SUB Err_mngmt
COM /Instrument/ @Mwm
DIM Err_msg$(255)
INTEGER Cme
CLEAR 7
REPEAT !
    OUTPUT @Mwm;"*ESR?"
    ENTER @Mwm;Cme
    OUTPUT @Mwm;" :SYST:ERR?"
    ENTER @Mwm;Err_msg$
    PRINT Err_msg$
    UNTIL NOT BIT(Cme,2) AND NOT BIT(Cme,4) AND NOT BIT(Cme,5)
    AND POS(Err_msg$,"+0")
Subend:SUBEND

Set_ese:SUB Set_ese
COM /Instrument/ @Mwm
OUTPUT @Mwm;"*ESE ";IVAL("00110100",2)
SUBEND

Identity:DEF FNIdentity$;
COM /Instrument/ @MwmV
DIM Identity$(50)
Identity$=""
OUTPUT @Mwm;"*RST"
OUTPUT @Mwm;"*OPC?"
ENTER @Mwm;Opc_done
OUTPUT @Mwm;"*IDN?"
ENTER @Mwm;Identity$
RETURN Identity$
FNEND

```

## Example Programs

---

### Example 2. Measure a Fabry Perot laser

This program measures the multiple laser lines of a Fabry Perot laser. It measures both the power and wavelengths of each line. First, the program sets the HP 86120B in the single-acquisition measurement mode. Then, it triggers the HP 86120B with the MEASure command to capture measurement data of the input spectrum. Because the data is stored in the instrument's memory, it can be queried as needed.

Refer to the introduction to this section for a description of each subroutine that is contained in this program.

```
COM /Instrument/ @Mwm
ASSIGN @Mwm TO 720
ON ERROR GOTO Error_msg,
Set_ese
PRINT USING "37A,33A";"Multi-Wavelength Meter Identity is :
";FNIdentityS

OUTPUT @Mwm;":INIT:CONT OFF"
ON TIMEOUT 7,5 CALL Err_mngmt
OUTPUT @Mwm;":MEAS:ARR:POW:WAV?"
ENTER @Mwm USING "#,K";Nb_wl
ALLOCATE Current_wl(1:Nb_wl)
ENTER @Mwm USING "#,K";Current_wl(*)
OUTPUT @Mwm;":FETC:ARR:POW?"
ENTER @Mwm USING "#,K";Nb_wl
ALLOCATE Current_pwr(1:Nb_wl)
ENTER @Mwm USING "#,K";Current_pwr(*)
FOR I=1 TO Nb_wl
    PRINT USING "22A,2D,6A,4D.2DE,4A,S2D.2D,3A";"The wavelength
    number ";Current_wl(I);" at ";Current_pwr(I);"dBm"
NEXT I
OFF TIMEOUT
STOP

Error_msg:
    PRINT "the prgm is aborted due to : ";ERRMS
END
```

## Example Programs

```
Err_mngmt:SUB Err_mngmt
  COM /Instrument/ @Mwm
  DIM Err_msg$(255)
  INTEGER Cme
  CLEAR 7
  REPEAT
    OUTPUT @Mwm; "**ESR?"
    ENTER @Mwm;Cme
    OUTPUT @Mwm; ":SYST:ERR?"
    ENTER @Mwm;Err_msg$
    PRINT Err_msg$
  UNTIL NOT BIT(Cme,2) AND NOT BIT(Cme,4) AND NOT BIT(Cme,5)
  AND Err$, "+0")
Subend:SUBEND

Set_ese:SUB Set_ese
  COM /Instrument/ @Mwm
  OUTPUT @Mwm; "**ESE";IVAL("00110100",2)
SUBEND

Identity:DEF FNIdentity$;
  COM /Instrument/ @Mwm
  DIM Identity$(50)
  Identity$=""
  OUTPUT @Mwm; "**RST"
  OUTPUT @Mwm; "**OPC?"
  ENTER @Mwm;Opc_done
  OUTPUT @Mwm; "**IDN?"
  ENTER @Mwm;Identity$
  RETURN Identity$
FNEND
```

## Example Programs

---

### Example 3. Measure a Fabry Perot laser's drift

This program measures the drift of a Fabry Perot laser. It measures drift in both power and wavelength of each line. First, the program sets the HP 86120B in the continuous-acquisition measurement mode. Then, it measures drift using commands from the CALCulate3 subsystem.

Notice the use of the Tempo subroutine to pause the program for 10 seconds while the HP 86120B measures the drift on the laser.

The use of the Err\_mngmt subroutine is optional. Refer to the introduction to this section for a description of each subroutine that is contained in this program.

```
COM /Instrument/ @Mwm
ASSIGN @Mwm TO 720
DIM Keys[1]
ON ERROR GOTO Error_msg
Set_ese
PRINT USING "37A,33A";"Multi-Wavelength Meter Identity is: "
;FNIdentityS
ON TIMEOUT 7,5 CALL Err_mngmt
Cmd_opc("*RST")
Cmd_opc(":INIT:CONT ON")
Cmd_opc(":CONF:ARR:POW:WAV")

! Turn on the drift calculation

Cmd_opc(":CALC3:DRIF:STAT ON")
Err_mngmt(":CALC3:DRIF:STAT ON")

! Turn off all drift states

Cmd_opc(":CALC3:DRIF:PRES")
Err_mngmt(":CALC3:DRIF:PRES")

! Turn on drift reference state

Cmd_opc(":CALC3:DRIF:REF:STAT ON")
Err_mngmt(":CALC3:DRIF:REF:STAT ON")

! Query the number of data points

OUTPUT @Mwm;":CALC3:POIN?"
ENTER @Mwm USING "#,K";Nb_pt
ALLOCATE Current_ref_wl(1:Nb_pt)
ALLOCATE Current_ref_pwr(1:Nb_pt)
```



```

! Query reference wavelengths and powers

OUTPUT @Mwm;":CALC3:DATA? WAV"
ENTER @Mwm USING "#,K";Current_ref_wl(*)
OUTPUT @Mwm;":CALC3:DATA? POW"
ENTER @Mwm USING "#,K";Current_ref_pwr(*)

! Turn off drift reference state

Cmd_opc(" :CALC3:DRIF:REF:STAT OFF")
Err_mngmt(" :CALC3:DRIF:REF:STAT OFF")

! Turn on drift max min calculation

Cmd_opc(" :CALC3:DRIF:DIFF:STAT ON")
Err_mngmt(" :CALC3:DRIF:DIFF:STAT ON")

Tempo(10)

ALLOCATE Current_diff_wl(1:Nb_pt)
ALLOCATE Current_diff_pw(1:Nb_pt)

! Query drift wavelengths and powers

OUTPUT @Mwm;":CALC3:DATA? WAV"
ENTER @Mwm USING "#,K";Current_diff_wl(*)
OUTPUT @Mwm;":CALC3:DATA? POW"
ENTER @Mwm USING "#,K";Current_diff_pw(*)
OFF TIMEOUT
FOR I=1 TO Nb_pt
  PRINT USING
    "18A,2D,6A,M4D.2DE,3A,21A,MDD.3DE,3A";"Wavelength number "
    ;I;" is : ";Current_ref_wl(I);" m";" with a drift from :
    ";Current_diff_wl(I);" m"
  PRINT USING "28A,SDD.2DE,4A,20A,MDD.3DE,3A,/" ;"it has a
  power level of
    : ";Current_ref_pwr(I);" dBm";" with a drift from :
    ";Current_diff_pw(I);" dB";
NEXT I
STOP

Error_msg: !
  PRINT "The program is aborted due to : ";ERRMS
END

```

## Example Programs

```
Err_mngmt:SUB Err_mngmt(OPTIONAL Cmd_msg$)
  COM /Instrument/ @Mwm
  DIM Err_msg$(255)
  INTEGER Cme
  CLEAR @Mwm
  REPEAT
    OUTPUT @Mwm;"*ESR?"
    ENTER @Mwm;Cme
    OUTPUT @Mwm;"*SYST:ERR?"
    ENTER @Mwm;Err_msg$
    IF NPAR>0 AND NOT POS(Err_msg$,"+0") THEN PRINT "This
command ";Cmd_msg$;" makes the following error :"  
    IF NOT POS(Err_msg$,"+0") THEN PRINT Err_msg$
  UNTIL NOT BIT(Cme,2) AND NOT BIT(Cme,4) AND NOT BIT(Cme,5)
  AND POS(Err_msg$,"+0")
Subend:SUBEND

Set_ese:SUB Set_ese
  COM /Instrument/ @Mwm
  OUTPUT @Mwm;"*ESE ";IVAL("00110100",2)
SUBEND

Identity:DEF FNIdentity$;
  COM /Instrument/ @Mwm
  DIM Identity$(50)
  Identity$=""
  OUTPUT @Mwm;"*RST"
  OUTPUT @Mwm;"*OPC?"
  ENTER @Mwm;Opc_done
  OUTPUT @Mwm;"*IDN?"
  ENTER @Mwm;Identity$
  RETURN Identity$
FNEND

Cmd_opc:SUB Cmd_opc(Set_cmd$)
  COM /Instrument/ @Mwm
  OUTPUT @Mwm;Set_cmd$
  OUTPUT @Mwm;"*OPC?"
  ENTER @Mwm;Opc_done$
SUBEND

Tempo:SUB Tempo(Temp)
  FOR I=Temp TO 0 STEP -1)
    DISP "Waiting for ";VAL$(I);" sec . . . "
    WAIT 1
  NEXT I
  DISP ""
SUBEND
```

## Example 4. Measure laser-line separation

This program measures the line separations on a Fabry Perot laser. It measures separation (delta) between power and wavelength of each line using commands from the CALCulate3 subsystem.

Refer to the introduction to this section for a description of each subroutine that is contained in this program.

```

COM /Instrument/ @Mwm
ASSIGN @Mwm TO 720
DIM Keys[1]
ON ERROR GOTO Error_msg
Set_ese
PRINT USING "37A,33A";"Multi-Wavelength Meter Identity is :
";FNIdentityS
ON TIMEOUT 7,5 CALL Err_mngmt
Cmd_opc("*RST")

! Change to list-by-wavelength display
Cmd_opc(":CONF:ARR:POW:WAV")

! Trigger and wait for one measurement
Cmd_opc(":INIT")
Cmd_opc("*WAI")

! Turn on delta mode
Cmd_opc(":CALC3:DELT:WPOW:STAT ON")

! Set first wavelength as reference
Cmd_opc(":CALC3:DELT:REF:WAV MIN")

! Query number of data points
OUTPUT @Mwm;":CALC3:POIN?"
ENTER @Mwm USING "#,K";Nb_pt
ALLOCATE Delta_wl(1:Nb_pt)
ALLOCATE Delta_pwr(1:Nb_pt)

! Query wavelengths and powers
OUTPUT @Mwm;":CALC3:DATA? WAV"
ENTER @Mwm;Delta_wl(*)
OUTPUT @Mwm;":CALC3:DATA? POW"
ENTER @Mwm;Delta_pwr(*)

```

## Example Programs

```
OFF TIMEOUT
FOR I=1 TO Nb_pt-1
  PRINT USING "6A,2D,17A,M4D.3D,31A,S2D.2D,4A";"Line :";I;"
  wavelength is : ";(Delta_wl(I)+((NOT I=1)*Delta_wl(1)))/
  1.0E-9;" nm. Absolute line level is : ";Delta_pwr(I)+(NOT
  I=1)*Delta_pwr(1);" dBm"
  PRINT USING "17A,2D,6A,M4D.3D,23A,2D,6A,S2D.2D,3A";"Delta Wl
  to line ",I+1," is : ";(Delta_wl(I+1)-(NOT I=1)*Delta_wl(I))/
  1.E-9;" nm, Delta Pwr to line ",I+1," is :
  ";(I=1)*(Delta_pwr(I+1))+(NOT I=1)*(Delta_pwr(I+1)-
  Delta_pwr(I));" dB"
NEXT I
PRINT USING "6A,2D,17A,M4D.3D,31A,S2D.2D,4A";"Line : ";I;"
wavelength is : ";(Delta_wl(1)+Delta_wl(Nb_pt))/1.0E-9;" nm.
Absolute line level is : ";Delta_pwr(1)+Delta_pwr(Nb_pt);" dBm"
STOP
Error_msg: !
  PRINT "The program is aborted due to : ";ERRM$
END

Err_mngmt:SUB Err_mngmt(OPTIONAL Cmd_msg$)
  COM /Instrument/ @Mwm
  DIM Err_msg$(255)
  INTEGER Cme
  CLEAR @Mwm
  REPEAT
    OUTPUT @Mwm;"*BSR?"
    ENTER @Mwm;Cme
    OUTPUT @Mwm;"*SYST:ERR?"
    ENTER @Mwm;Err_msg$
    IF NPAR>0 AND NOT POS(Err_msg$,"+0") THEN PRINT "This
    command ";Cmd_msg$;" makes the following error : "
    IF NOT POS(Err_msg$,"+0") THEN PRINT Err_msg$
    UNTIL NOT BIT(Cme,2) AND NOT BIT(Cme,4) AND NOT BIT(Cme,5)
    AND POS(Err_msg$,"+0")
  Subend:SUBEND

Set_ese:SUB Set_ese
  COM /Instrument/ @Mwm
  OUTPUT @Mwm;"*ESE ";IVAL("00110100",2)
SUBEND

Identity:DEF FNIdentity$;
  COM /Instrument/ @Mwm
  DIM Identity$(33)
  Identity$=""
  OUTPUT @Mwm;"*RST"
  OUTPUT @Mwm;"*OPC?"
  ENTER @Mwm;Opc_done
  OUTPUT @Mwm;"*IDN?"
  ENTER @Mwm;Identity$
  RETURN Identity$
FNEND
```

## Example Programs

```
Cmd_opc:SUB Cmd_opc(Set_cmd$)
COM /Instrument/ @Mwm
OUTPUT @Mwm;Set_cmd$
OUTPUT @Mwm;"*OPC?"
ENTER @Mwm;Opc_done$
SUBEND
```

## Example Programs

---

### Example 5. Measure signal-to-noise ratio

This program measures signal-to-noise ratios on a Fabry Perot laser. It measures the ratio for each line using commands from the CALCulate3 subsystem.

Refer to the introduction to this section for a description of each subroutine that is contained in this program.

```
COM /Instrument/ @Mwm
ASSIGN @Mwm TO 720
DIM Keys[1]
ON ERROR GOTO Error_msg,
Set_ese
PRINT USING "37A,33A";"Multi-Wavelength Meter Identity is :
";FNIdentityS
ON TIMEOUT 7,5 CALL Err_mngmt
Cmd_opc(" *RST")
OUTPUT @Mwm;" :MEAS:ARR:POW:WAV?"
ENTER @Mwm USING "#,K";Nb_pt
ALLOCATE Current_wl(1:Nb_pt)
ENTER @Mwm USING "#,K";Current_wl(*)
OUTPUT @Mwm;" :FETC:ARR:POW?"
ENTER @Mwm USING "#,K";Nb_pt
ALLOCATE Current_pwr(1:Nb_pt)
ENTER @Mwm USING "#,K";Current_pwr(*)

! Turn signal-to-noise ratio on

Cmd_opc(" :CALC3:SNR:STAT ON")
Err_mngmt(" :CALC3:SNR:STAT ON")

! Set first wavelength as noise reference

Cmd_opc(" :CALC3:SNR:REF:WAV MIN")
Err_mngmt(" :CALC3:SNR:REF:WAV MIN")

! Query number of data points

OUTPUT @Mwm;" :CALC3:POIN?"
ENTER @Mwm USING "#,K";Nb_pt
ALLOCATE Snr_pwr(1:Nb_pt)

! Query signal-to-noise values

OUTPUT @Mwm;" :CALC3:DATA? POW"
ENTER @Mwm;Snr_pwr(*)
OFF TIMEOUT
```

## Example Programs

```
FOR I=1 TO Nb_pt
  PRINT USING "7A,2D,17A,M4D.3D,25A,S2D.2D,22A,2D.2D,3A";"Line
  : ";I;" wavelength is : ";Current_wl(I)/1.0E-9;" nm, absolute
  level is : ";Current_pwr(I);" dBm, with a SNR of :
  ";Snr_pwr(I);" dB"
NEXT I
STOP

Error_msg: !
  PRINT "The program is aborted due to : ";ERRMS
END

Err_mngmt:SUB Err_mngmt(OPTIONAL Cmd_msg$)
  COM /Instrument/ @Mwm
  DIM Err_msg$(255)
  INTEGER Cme
  CLEAR @Mwm
  REPEAT !
    OUTPUT @Mwm;"*ESR?"
    ENTER @Mwm;Cme
    OUTPUT @Mwm;".SYST:ERR?"
    ENTER @Mwm;Err_msg$
    IF NPAR>0 AND NOT POS(Err_msg$,"+0") THEN PRINT "This
    command ";Cmd_msg$;" makes the following error : "
    IF NOT POS(Err_msg$,"+0") THEN PRINT Err_msg$
  UNTIL NOT BIT(Cme,2) AND NOT BIT(Cme,4) AND NOT BIT(Cme,5)
  AND POS(Err_msg$,"+0")
Subend:SUBEND

Set_ese:SUB Set_ese
  COM /Instrument/ @Mwm
  OUTPUT @Mwm;"*ESE ";IVAL("00110100",2)
SUBEND

Identity:DEF FNIdentity$;
  COM /Instrument/ @Mwm
  DIM Identity$(50)
  Identity$=""
  OUTPUT @Mwm;"*RST"
  OUTPUT @Mwm;"*OPC?"
  ENTER @Mwm;Opc_done
  OUTPUT @Mwm;"*IDN?"
  ENTER @Mwm;Identity$
  RETURN Identity$
FNEND

Cmd_opc:SUB Cmd_opc(Set_cmds)
  COM /Instrument/ @Mwm
  OUTPUT @Mwm;Set_cmds
  OUTPUT @Mwm;"*OPC?"
  ENTER @Mwm;Opc_done$
SUBEND
```

## Example Programs

---

### Example 6. Increase a source's wavelength accuracy

This example program uses the HP 86120B to increase the absolute wavelength accuracy of HP 8167A, HP 8168B, and HP 8168C Tunable Laser Sources. Essentially, the HP 86120B's accuracy is transferred to the tunable laser source. The absolute accuracy of the tunable laser source is increased from  $<\pm 0.1$  nm to  $<\pm 0.005$  nm which is the HP 86120B's absolute accuracy (at 1550 nm).

In order to run this program, the tunable laser source's firmware must support the automatic alignment command, WAVEACT.

The program uses the following measurement algorithm:

- Identify and initialize the HP 86120B and tunable laser source
- Ask user for desired wavelength
- Set wavelength of tunable laser source
- Turn tunable laser source's output on
- Enter loop
  - Measure wavelength
  - Compare wavelength to desired wavelength
  - Realign tunable laser source's wavelength
  - Check if wavelength changed from last pass
- Repeat until ( $\Delta$  wavelength  $< 0.0015$  nm or wavelength is stable)



## Example Programs

```
COM Current_wl,Diff_wl,Target_wl,Previous_diff,Diff_diff
Current_wl=0
Diff_wl=0
Target_wl=0
Previous_diff=0
Diff_diff=0

ASSIGN @Tls TO 724
ASSIGN @Mwm TO 720

! Initialize instrument

DIM Identity$(50)
Identity$=""
OUTPUT @Tls;"*CLS"
OUTPUT @Tls;"*IDN?"
ENTER @Tls;identity$
PRINT "TLS IS A ";identity$
OUTPUT @Mwm;"*RST"
OUTPUT @Mwm;"*CLS"
OUTPUT @Mwm;"*IDN?"
ENTER @Mwm;Identity$
PRINT "MWM IS A ";identity$

! Ask user for desired wavelength

INPUT "What wavelength (nm)do you wish to have",Target_wl
Target_wl=Target_wl*1.0E-9
PRINT "the target wavelength is : ";Target_wl

! Set wavelength of tunable laser source

OUTPUT @Tls; ":WAVE ";VAL$(Target_wl)
OUTPUT @Tls; ":OUTP ON"

! Enter realignment loop

REPEAT
  OUTPUT @Mwm;"MEAS:SCAL:POW:WAV?"
  ENTER @Mwm;Current_wl
  PRINT "The current wavelength is : ";VAL$(Current_wl)
  Diff_wl=PROUND(ABS(Target_wl-Current_wl),-16)
  PRINT "Diff between target & Current is (+ or -) :
";VAL$(Diff_wl)
  OUTPUT @Tls;"WAVEACT ";VAL$(Current_wl)
  Diff_diff=PROUND(ABS(Diff_wl-Previous_diff),-16)
  PRINT "differential difference between two turn :
";VAL$(Diff_diff)
  Previous_diff=Diff_wl
UNTIL (Diff_wl<1.5*1.0E-12) OR (Diff_diff=0)
END
```

## Lists of Commands

### Lists of Commands

**Table 3-7. Programming Commands (1 of 6)**

Command	Description	Code
Codes: S indicates a standard SCPI command. I indicates an instrument specific command.		
<b>Common Commands</b>		
*CLS	Clears all event registers and the error queue.	
*ESE	Sets the bits in the standard-event status enable register	
*ESR?	Queries value standard-event status register.	
*IDN?	Queries instrument model number and firmware version.	
*OPC	Sets operation complete bit of the standard-event status register	
*RCL	Recalls a saved instrument state.	
*RST	Resets instrument.	
*SAV	Saves an instrument state.	
*SRE	Sets bits in service-request enable register	
*STB	Queries value of status byte	
*TRG	Triggers acquisition of measurement data.	
*TST?	Performs an instrument self test	
*WAI	Causes instrument to finish processing current command before continuing.	
<b>Measurement Instructions</b>		
:CONFigure	Configures instrument for wavelength, wavenumber, frequency, power, and coherence length measurements.	I
:FETCh	Queries wavelength, wavenumber, frequency, power, and coherence length measurements that have already been captured.	I
:MEASure	Configures, measures, and queries wavelength, wavenumber, frequency, power, and coherence length measurements.	I
:READ	Measures and queries wavelength, wavenumber, frequency, power, and coherence length measurements.	I

Table 3-7. Programming Commands (2 of 6)

Command	Description	Code
Codes: S indicates a standard SCPI command. I indicates an instrument specific command.		
<b>CALCulate1 Subsystem</b>		
:CALCulate1:DATA?	Queries the uncorrected frequency-spectrum data of the input signal.	S
:CALCulate1:TRANSform:FREQuency:POINts?	Sets and queries the number of points in the data set.	S
<b>CALCulate2 Subsystem</b>		
:CALCulate2:DATA?	Queries the corrected frequency-spectrum data of the input signal.	S
:CALCulate2:PEXCursion	Sets the peak excursion limit.	I
:CALCulate2:POINts?	Queries the number of points in the data set.	I
:CALCulate2:PTHReshold	Sets the peak threshold limit.	I
:CALCulate2:PWAVerage[:STATe]?	Places the instrument in the average-wavelength mode. Data queries return the power-weighted average frequency, wavelength, or wavenumber or total power.	I
:CALCulate2:WLIMit[:STATe]	Limits input wavelength range of the HP 86120B.	I
:CALCulate2:WLIMit:STARt:FREQuency	Sets the starting frequency for the wavelength limit range.	I
CALCulate2:WLIMit:STARt[:WAVelength]	Sets the starting wavelength for the wavelength limit range.	I
CALCulate2:WLIMit:STARt:WNUMber	Sets the starting wavenumber for the wavelength limit range.	I
:CALCulate2:WLIMit:STOP:FREQuency	Sets the stopping frequency for the wavelength limit range.	I
CALCulate2:WLIMit:STOP[:WAVelength]	Sets the stopping wavelength for the wavelength limit range.	I
CALCulate2:WLIMit:STOP:WNUMber	Sets the stopping wavenumber for the wavelength limit range.	I
<b>CALCulate3 Subsystem</b>		
CALCulate3:ASNR:CLEar	Resets and restarts the signal-to-noise ratio averaging	I
CALCulate3:ASNR:COUNT	Sets the number of measurements to average the signal-to-noise ratio	I
CALCulate3:ASNR[:STATe]	Turns signal-to-noise ratio averaging mode on and off	I
:CALCulate3:DATA?	Queries the data resulting from delta, drift, and signal-to-noise measurements.	S
:CALCulate3:DELTA:POWer[:STATe]	Turns the delta power measurement mode on and off.	I

## Lists of Commands

**Table 3-7. Programming Commands (3 of 6)**

Command	Description	Code
Codes: S indicates a standard SCPI command. I indicates an instrument specific command.		
:CALCulate3:DELTA:REFERENCE:FREQUENCY	Selects the signal to be used as the reference for the DELTA calculations.	I
:CALCulate3:DELTA:REFERENCE:POWER?	Queries the power level of the reference signal.	I
:CALCulate3:DELTA:REFERENCE[:WAVELENGTH]	Selects the signal to be used as the reference for the DELTA calculations.	I
:CALCulate3:DELTA:REFERENCE:WNUMBER	Selects the signal to be used as the reference for the DELTA calculations.	I
:CALCulate3:DELTA:WAVELENGTH[:STATE]	Turns the delta wavelength measurement mode on and off.	I
:CALCulate3:DELTA:WPOWER[:STATE]	Turns the delta wavelength and power measurement mode on and off.	I
:CALCulate3:DRIFT:DIFFERENCE[:STATE]	Sets the drift calculation to subtract the minimum values measured from the maximum values measured.	I
:CALCulate3:DRIFT:MAXIMUM[:STATE]	Sets the drift calculation to return the maximum power (frequency) values measured.	I
:CALCulate3:DRIFT:MINIMUM[:STATE]	Sets the drift calculation to return the minimum power (frequency) values measured.	I
:CALCulate3:DRIFT:PRESET	Turns off all the drift states for DIFFERENCE, MAXIMUM, MINIMUM, and REFERENCE.	I
:CALCulate3:DRIFT:REFERENCE:RESET	Places the current list of signals into the reference list.	I
:CALCulate3:DRIFT:REFERENCE[:STATE]	Turns the drift state on and off so that CALC3:DATA? will return the reference signal list.	I
:CALCulate3:DRIFT[:STATE]	Turns the drift measurement calculation on and off.	I
:CALCulate3:POINTS?	Queries the number of points in the data set.	I
CALCulate3:PRESET	Turns off any CALCulate3 calculation that is on.	I
:CALCulate3:SNR:AUTO	Selects the internal or externally entered frequency value for the noise measurement reference in the SNR calculation.	I
:CALCulate3:SNR:REFERENCE:FREQUENCY	Sets the frequency used for the noise measurement reference in the SNR calculation.	I
:CALCulate3:SNR:REFERENCE[:WAVELENGTH]	Sets the wavelength used for the noise measurement reference in the SNR calculation.	I

Table 3-7. Programming Commands (4 of 6)

Command	Description	Code
Codes: \$ indicates a standard SCPI command.   indicates an instrument specific command.		
:CALCulate3:SNR:REFERENCE:WNUMber	Sets the wave number used for the noise measurement reference in the SNR calculation.	
:CALCulate3:SNR[:STATe]	Turns the SNR calculation on and off.	
<b>DISPlay Subsystem</b>		
:DISPlay:MARKer:MAXimum	Sets the marker to the signal with the largest power.	
:DISPlay:MARKer:MAXimum:LEFT	Moves marker to signal with the next lower wavelength or frequency.	
:DISPlay:MARKer:MAXimum:NEXT	Moves the marker to the signal with the closest power level just below the power level of the signal at the current marker position.	
:DISPlay:MARKer:MAXimum:PREVIOUS	Moves the marker to the signal with the closest power level just above the power level of the signal at the current marker position.	
:DISPlay:MARKer:MAXimum:RIGHT	Moves marker to the next higher wavelength or frequency.	
:DISPlay[:WINDow]:GRAPHics:STATe	Turns the instrument display of the power bars on and off.	S
<b>HCOPY Subsystem</b>		
:HCOPY:IMMEDIATE	Starts a printout.	S
<b>SENSE Subsystem</b>		
:SENSE:CORREction:ELEVation	Sets the elevation value used by the instrument to compensate for air dispersion.	
:SENSE:CORREction:OFFSet:MAGNitude	Sets the power offset value used by the instrument.	S
:SENSE:CORREction:MEDIUM	Sets the instrument to return the wavelength reading in a vacuum when the parameter is on. Parameters are VAC and AIR.	
:SENSE:DATA?	Queries the time domain samples of the input signal.	
<b>STATus Subsystem</b>		
:STATus:{OPERation   QUEStionable}:CONDition?	Returns the value for the condition register for the node.	S
:STATus:{OPERation   QUEStionable}:EVENT?	Returns the value of the event register for the node.	S
:STATus:{OPERation   QUEStionable}:ENABLE	Sets the enable register.	S

## Lists of Commands

**Table 3-7. Programming Commands (5 of 6)**

Command	Description	Code
Codes: S indicates a standard SCPI command. I indicates an instrument specific command.		
.STATUS:{OPERation   QUEStionable}:PTRansition	Sets the positive transition filter register.	S
.STATUS:{OPERation   QUEStionable}:NTRansition	Sets the negative transition filter register.	S
.STATUS:PRESet	Presets the enable registers for all status nodes.	S
<b>SYSTEM Subsystem</b>		
.SYSTEM:ERRor?	Queries an error from the error queue.	S
.SYSTEM:HELP:HEADers?	Queries an ASCII listing of all HP 86120B remote commands.	I
.SYSTEM:PRESet	Performs the equivalent of a front-panel PRESET key press.	S
.SYSTEM:VERSion	Queries the version of SCPI with which this instrument is compliant.	S

Table 3-7. Programming Commands (6 of 6)

Command	Description	Code
Codes: S indicates a standard SCPI command. I indicates an instrument specific command.		
<b>TRIGger Subsystem</b>		
:ABORt	Stops the current measurement sequence.	S
:INITiate:IMMediate	Places the instrument into the initiated state and initiates a new measurement sequence.	S
:INITiate:CONTinuous	Sets the instrument for single or continuous measurement.	S
<b>UNIT Subsystem</b>		
:UNIT[:POWer]	Sets the power units to watts (linear) or dBm (logarithmic).	S

## Lists of Commands

**Table 3-8. Keys Versus Commands (1 of 3)**

Key	Equivalent Command
$\Delta$ PWR	:CALCulate3:DELTA:POWer[:STATe]
$\Delta$ WL	:CALCulate3:DELTA:WAVelength[:STATe]
$\Delta$ WL/PWR	:CALCulate3:DELTA:WPOWer[:STATe]
Appl's	<i>See</i> COH LEN, DRIFT, <i>and</i> S/N
AUTO	:CALCulate3:SNR:AUTO ON
Avg WL	:CALCulate2:PWAVerage[:STATe]
BAR OFF	:DISPlay[:WINDow]:GRAPhics:STATe
BAR ON	:DISPlay[:WINDow]:GRAPhics:STATe
CAL	<i>See</i> ELEV, PWR OFS, STD AIR, <i>and</i> VACUUM
CM-1	:MEASure:ARRAy:POWer:WNUMber
COH LEN	:MEASure:LENGth:COHerence:CLENGth
Cont	:INITiate:CONTInuous ON
DBM	UNIT:POWer
DRIFT	:CALCulate3:DRIFt[:STATe]
ELEV	:SENSe:CORRection:ELEVation
EXIT	none
FAST	<i>See</i> UPDATE
HP-IB	none
LIM OFF	:CALCulate2:WLIMit[:STATe] OFF
LIM ON	:CALCulate2:WLIMit[:STATe] ON
List by Power	:CONFigure:ARRAy:POWer
List by WL	:MEASure:ARRAy:POWer:WAVelength
MAX-MIN	:CALCulate3:DRIFt:MINimum[:STATe] <i>and</i> :CALCulate3:DRIFt:MAXimum[:STATe]
MW	UNIT:POWer



Table 3-8. Keys Versus Commands (2 of 3)

Key	Equivalent Command
NEXT PK	:DISPlay:MARKer:MAXimum:NEXT
NEXT WL	:DISPlay:MARKer:MAXimum:RIGHT
NM	:MEASure:ARRAy:POWer:WAVelength
NORMAL	See UPDATE
OFF	:CALCulate3:DELTA:POWer[:STATe]
ON	:CALCulate3:DELTA:POWer[:STATe]
PEAK	:DISPlay:MARKer:MAXimum
Peak WL	See NEXT PK, NEXT WL, PEAK, PREV PK, and PREV WL
PK EXC	:CALCulate2:PEXCursion
PK THLD	:CALCulate2:PTHReshold
POWER	:UNIT:POWer
Preset	:SYSTEM:PRESet
PREV PK	:DISPlay:MARKer:MAXimum:PREVious
PREV WL	:DISPlay:MARKer:MAXimum:LEFT
Print	:HCOPY:IMMEDIATE
PWR BAR	See BAR ON and BAR OFF
PWR OFF	:SENSe:CORRection:OFFSet:MAGNitude
RESET	:CALCulate3:DRIFT:REFeRence:RESet
S/N	:CALCulate3:SNR:STATe
S/N AVG	:CALCulate3:ASNR:STATe
SELECT	:CONFigure:POWer
Setup	See CAL, UNITS, and UPDATE
Single	:INITiate:CONTInuous OFF
START WL	:CALCulate2:WLIMit:START

## Lists of Commands

**Table 3-8. Keys Versus Commands (3 of 3)**

Key	Equivalent Command
STOP WL	:CALCulate2:WLIMit:STOP
STD AIR	:SENSe:CORRection:MEDIum AIR
THRSHLD	<i>See PK EXC and PK THLD</i>
THZ	:MEASure:ARRay:POWer:FREQuency
UNITS	:UNIT:POWer
UPDATE	Measurement Instructions and :CALCulate1:TRANSform:FREQuency:POINts
USER	:CALCulate3:SNR:AUTO OFF
USER WL	:CALCulate3:SNR:REFerence[:WAVelength]
UW	UNIT:POWer
VACUUM	:SENSe:CORRection:MEDIum VACuum
WL	<i>See CM, NM, and THZ</i>
WL LIM	CALCulate2:WLIMit[:STATe]
WL REF	<i>See AUTO, USER, and USER WL</i>

---

## Programming Commands



## Programming Commands

This chapter is the reference for all HP 86120B programming commands. Commands are organized by subsystem.

**Table 4-1. Notation Conventions and Definitions**

<b>Convention</b>	<b>Description</b>
< >	Angle brackets indicate values entered by the programmer.
	"Or" indicates a choice of one element from a list.
[ ]	Square brackets indicate that the enclosed items are optional.
{ }	When several items are enclosed by braces, one, and only one of these elements must be selected.
<integer>	An ASCII string representing an integer. This is defined by the IEEE 488.2 <NR1> format.
<real>	An ASCII string representing a real number. This is defined by the IEEE 488.2 <NR2> or <NRf> formats.

**Contents**

Common Commands	4-4
Measurement Instructions	4-16
CALCulate1 Subsystem	4-27
CALCulate2 Subsystem	4-32
CALCulate3 Subsystem	4-44
CONFigure Measurement Instruction	4-67
DISPlay Subsystem	4-68
FETCh Measurement Instruction	4-72
HCOPy Subsystem	4-73
MEASure Measurement Instruction	4-74
READ Measurement Instruction	4-75
SENSe Subsystem	4-76
STATus Subsystem	4-82
SYSTem Subsystem	4-89
TRIGger Subsystem	4-95
UNIT Subsystem	4-99

## Common Commands

Common commands are defined by the IEEE 488.2 standard. They control generic device functions which could be common among many different types of instruments. Common commands can be received and processed by the instrument whether they are sent over the HP-IB as separate program messages or within other program messages.

---

### **\*CLS**

The \*CLS (clear status) command clears all the event status registers summarized in the status byte register.

**Syntax**

\*CLS

**Description**

With the exception of the output queue, all queues that are summarized in the status byte register are emptied. The error queue is also emptied. Neither the event status enable register, nor the service request enable register are affected by this command.

After the \*CLS command, the instrument is left in the idle state. The command does not alter the instrument setting. \*OPC and \*OPC? actions are cancelled.

This command cannot be issued as a query.

---

### **\*ESE**

The \*ESE (event status enable) command sets the bits in the event status enable register and enables the corresponding bits in the event status register.

---

**Syntax**                    \*ESE <integer>  
                               \*ESE?

<integer> is a mask from 0 to 255.

**Description**

The event status enable register contains a mask value for the bits to be enabled in the event status register. A bit set to one (1) in the event status enable register enables the corresponding bit in the event status register to set the event summary bit in the status byte register. A zero (0) disables the bit. Refer to the following table for information about the event status enable register bits, bit weights, and what each bit masks. The event status enable register is cleared at power-on. The \*RST and \*CLS commands do not change the register. The \*ESE? query returns the value of the event status enable register.

**Table 4-2. Event Status Enable Register**

Bit <sup>a</sup>	Bit Weight	Enables
7	128	PDN – Power On
6	64	Not Used
5	32	CME – Command Error
4	16	EXE – Execution Error
3	8	DDE – Device Dependent Error
2	4	QYE – Query Error
1	2	Not Used
0	1	OPC – Operation Complete

a. A high enables the event status register bit.

**Query Response**        <integer> is a mask from 0 to 255.

**Example**

OUTPUT 720; "\*ESE 32"

In this example, the \*ESE 32 command enables CME ( event summary bit) bit 5 of the event status enable register. Therefore, when an incorrect programming command is received, the CME (command error bit) in the status byte register is set.

Programming Commands  
**Common Commands**

---

**\*ESR?**

The \*ESR (event status register) query returns the value of the event status register.

**Syntax**

\*ESR?

**Description**

When you read the standard event status register, the value returned is the total of the bit weights of all of the bits that are set to one at the time you read the byte. The following table shows each bit in the event status register and its bit weight. The register is cleared when it is read.

**Table 4-3. Standard Event Status Register**

Bit	Bit Weight	Condition
7	128	PON – Power On
6	64	Not Used
5	32	CME – Command Error
4	16	EXE – Execution Error
3	8	DDE – Device Dependent Error
2	4	QYE – Query Error
1	2	Not Used
0	1	OPC – Operation Complete

**Query Response**

<integer> ranges from 0 to 255.



**Example**            `OUTPUT 720;"*ESR?"`  
                      `ENTER 720;Event`  
                      `PRINT Event`

---

## \*IDN?

The \*IDN? (identification number) query returns a string value which identifies the instrument type and firmware version.

**Syntax**            `*IDN?`

**Description**        An \*IDN? query must be the last query in a program message. Any queries after the \*IDN? query in a program message are ignored.  
  
The maximum length of the identification string is 50 bytes.

**Query Response**    The following identification string is returned. The last entry in the string is the firmware version number; this value may vary between instruments.  
  
`HEWLETT-PACKARD, 86120B, 0, 1.000`

**Example**            `DIM Id$(50)`  
                      `OUTPUT 720;"*IDN?"`  
                      `ENTER 720;Id$`  
                      `PRINT Id$`

---

## \*OPC

The \*OPC (operation complete) command sets the operation complete bit in the event status register when all pending device operations have finished.

**Syntax**            `*OPC`  
                      `*OPC?`

**Description**        The \*OPC? query places an ASCII "1" in the output queue when all pending device operations have finished.

## Programming Commands

### Common Commands

This command is useful when the computer is sending commands to other instruments. The computer can poll the event status register to check when the HP 86120B has completed the operation. Use the \*OPC? query to ensure all operations have completed before continuing the program. By following a command with an \*OPC? query and an ENTER statement, the program will pause until the response (ASCII "1") is returned by the instrument.

Be sure the computer's timeout limit is at least two seconds, since some of the HP 86120B commands take approximately one second to complete.

**Query Response** 1

**Example** OUTPUT 720; "\*OPC?"  
ENTER 720;OpS

---

### \*RCL

This command recalls a saved instrument state.

**Syntax** \*RCL <integer>

<integer> range is 1 to 4.

**Description** For a description of an instrument state, see \*SAV command.

---

## \*RST

The \*RST (reset) command returns the HP 86120B to a known condition.

**Syntax** \*RST

**Description** For a listing of reset conditions, refer to the following table. This command cannot be issued as a query. Since this command places the instrument in single measurement acquisition mode, any current data is marked as invalid and a measurement query such as :FETCh? results in error number -230, "Data corrupt or stale". You must initiate a new sweep with :INIT:IMM before you can use the :FETCh command.

---

## \*SAV

This command saves an instrument state.

**Syntax** \*SAV <integer>  
<integer> range is 1 to 4.

**Description** The following constitutes an instrument state: single/continuous measurement mode, power bar on/off, vacuum/STD air mode, normal/fast update, list by WL, list by Pwr, peak, or avg display mode, frequency units, power units, elevation, peak excursion, peak threshold, power offset, signal-to-noise auto mode on/off, wavelength limit on/off, wavelength limit start, wavelength limit stop, and signal-to-noise average count.

Programming Commands

**Common Commands**

**Table 4-4. Conditions Set by \*RST Reset**

<b>Item</b>	<b>Setting</b>
Display mode	single wavelength
Wavelength range limiting	on
Start wavelength	1200 nm
Stop wavelength	1650 nm
Graphical display	off
Measurement acquisition	single
Wavelength calibration	vacuum
Elevation correction value	0 meters
Wavelength units	nm
Amplitude units	dBm
Power offset	0 dB
Peak threshold	10 dB
Peak excursion	15 dB
Measurement speed	normal
Number of uncorrected data points	34123
Delta Measurements:	
$\Delta$ power	off
$\Delta$ wavelength	off
$\Delta$ wavelength and power	off
reference signal position	700 nm
Drift measurements	off
Coherence length measurements	off

**Table 4-4. Conditions Set by \*RST Reset (Continued)**

Item	Setting
Signal-to-Noise Measurements:	
measurement	off
wavelength reference	auto
reference (user) wavelength	1550 nm in vacuum
number of averages (count)	100
HP-IB address	not affected
Power-bar display	on

### **\*SRE**

The \*SRE (service request enable) command sets the bits in the service request enable register.

**Syntax**

\*SRE <integer>  
 \*SRE?

<integer> is defined as an integer mask from 0 to 255.

**Description**

The service request enable register contains a mask value for the bits to be enabled in the status byte register. A bit set to one in the service request enable register enables the corresponding bit in the status byte register to generate a service request. A zero disables the bit. The following table lists the bits in the service request enable register and what they mask.

Programming Commands

**Common Commands**

The service request enable register is cleared when the instrument is turned on. The \*RST and \*CLS commands do not change the register. The \*SRE? query returns the value of the service request enable register.

**Table 4-5. Service Request Enable Register**

Bit <sup>a</sup>	Bit Weight	Enables
7	128	Not Used
6	64	Not Used
5	32	Event Status Bit (ESB)
4	16	Message Available (MAV)
3	8	Not Used
2	4	Error queue status
1	2	Not Used
0	1	Not Used

a. High enables the status byte register bit.

**Query Response**

<integer> from 0 to 63 or from 128 to 191.

**Example**

```
OUTPUT 720; "*SRE 32"
```

In this example, the command enables ESB (event summary) bit 5 in the status byte register to generate a service request.

## \*STB?

The \*STB (status byte) query returns the current value of the instrument's status byte.

### Syntax

\*STB?

### Description

The master summary status (MSS) bit 6 indicates whether or not the device has at least one reason for requesting service. When you read the status byte register, the value returned is the total of the bit weights of all of the bits set to one at the time you read the byte. The following table shows each bit in the status byte register and its bit weight. The \*STB? query does not affect the contents of the status byte register.

**Table 4-6. Status Byte Register**

Bit	Bit Weight	Condition
7	128	Not Used
6	64	Master Summary Status (MSS)
5	32	Event Status Bit (ESB)
4	16	Message Available (MAV)
3	8	Not Used
2	4	Error queue status
1	2	Not Used
0	1	Not Used

### Query Response

*<integer>* from 0 to 255.

### Example

```
OUTPUT 720; "*STB?"
ENTER 720; Value
PRINT Value
```

Programming Commands  
**Common Commands**

---

**\*TRG**

The \*TRG (trigger) command is identical to the group execute trigger (GET) message or RUN command.

**Syntax**           \*TRG

**Description**       This command acquires data according to the current settings. This command cannot be issued as a query. If a measurement is already in progress, a trigger is ignored, and an error is generated.

**Example**            The following example starts the data acquisition according to the current settings.

```
OUTPUT 720; "**TRG"
```

---

**\*TST?**

The \*TST (test) query starts a self-test on the instrument.

**Syntax**           \**TST?*

**Description**       The result of the test is placed in the output queue. A zero indicates the test passed and a non-zero value indicates the test failed. The instrument will initiate a measurement and check for any hardware errors after the measurement is complete.

**Query Response**   <*integer*>

**Example**

```
OUTPUT 720; "**TST?"
ENTER 720;Result
PRINT Result
```

---



## **\*WAI**

The \*WAI command prevents the instrument from executing any further commands until the current command has finished executing.

### **Syntax**

\*WAI

### **Description**

All pending operations are completed during the wait period. This command cannot be issued as a query.

---

## Measurement Instructions

Use the measurement instructions documented in this section to perform measurements and return the desired results to the computer. Four basic measurement instructions are used: CONFigure, FETCh, READ, and MEASure. Because the command trees for each of these four basic measurement instructions are identical, only the MEASure tree is documented.

To perform a measurement, append to the measurement instruction a POWer or LENGth function. The POWer functions select power, frequency, wavelength, or wave number measurements. Use the LENGth functions to configure the instrument to measure coherence length. The instrument measures the coherence length in the time domain by rectifying and low-pass filtering the interferogram. The resulting waveform is then curve fit into a decaying exponential. Refer to "Measuring Coherence Length" on page 2-33.

When the :SCALAR command is used, data for a single measurement value is returned. When the :ARRAY command is used, multiple data values are returned.

The MEASure measurement instruction always acquires new measurement data. In order to obtain both wavelength and power values from the same measurement data, use two FETCh commands. This is shown in the following program fragment:

```
OUTPUT 720;":INIT:CONT OFF;"
OUTPUT 720;":CONF:ARR:POW MAX"
OUTPUT 720;":INIT:IMM"
OUTPUT 720;":FETC:ARR:POW?"
ENTER 720:powers$
OUTPUT 720;":FETC:ARR:POW:WAV?"
ENTER 720:wavelengths$
```

In the example above, the data in the power and wavelength arrays are returned in the same order so that powers can be matched to wavelengths. You can also send a MEASure command followed by a FETCh command.

The commands in this subsystem have the following command hierarchy:

```
{:MEASure | :READ[?] | :FETCh[?] | :CONFIgure[?]}  
  {:ARRay | [:SCALar]}  
    :POWER[?]  
      :FREQuency[?]  
      :WAVelength[?]  
      :WNUMber[?]  
  [SCALar]:LENGth  
    :COHerence  
      :ALPHa?  
      :BETA?  
      [:CLEngth]?  
      :DELay?
```

## MEASure{:ARRAY | [:SCALAR]} :POWER?

Returns amplitude values.

### Syntax

```
:POWER? [<expected_value>[,<resolution>]]
```

Used With	<expected_value>	<resolution>
SCALAR	optional	ignored
ARRAY	ignored	ignored

### Description

When used with a :SCALAR command, a single value is returned. The display is placed in the single-wavelength mode, and the marker is placed on the signal having a power level that is closest to the <expected\_value> parameter.

When used with an :ARRAY command, an array of amplitudes is returned. The display is placed in the list-by-power mode.

Returned values are in the current power units. Wavelength units are not affected.

#### CONFIGure command

When this function is used with the CONFIGure command, the query question mark character "?" *must not* be included in the string. However, the FETCH, READ, and MEASure command are queries and require the question mark. Refer to the examples for this command.

### <expected\_value> Constants

MAXimum	Displays the highest power signal
MINimum	Displays the lowest power signal
DEFault	Displays the signal at the current marker position

**Examples**

```
:CONF:ARR:POW  
:FETC:ARR:POW?  
:READ:ARR:POW?  
:MEAS:ARR:POW?  
  
:CONF:SCAL:POW -10 dBm  
:FETC:SCAL:POW? MAX  
:READ:SCAL:POW? MIN  
:MEAS:SCAL:POW? DEF
```

**Query Response**

The following line is an example of a returned string when :MEAS:SCAL:POW? MAX is sent:

```
-5.88346500E+000
```

If six laser lines are located and :MEAS:ARR:POW? is sent, the following string could be returned. Notice that the first returned number indicates the number of laser-line values returned in the query. The measurement units are in dBm.

```
6, -1.37444400E+001, -1.10996100E+001, -9.62396600E+000,  
-7.94024500E+000, -7.01303200E+000, -1.04536200E+001
```

## MEASure{:ARRay | [:SCALar]] :POWer:FREQUency

Returns frequency values.

### Syntax

```
:POWer:FREQUency? [<expected_value>[,<resolution>]]
```

Used With	<expected_value>	<resolution>
SCALar	optional	optional
ARRay	ignored <sup>a</sup>	optional

- a. Although ignored, this argument must be present if the resolution argument is specified.

### Description

When used with a :SCALar command, a single value is returned. The display is placed in the single-wavelength mode, and the marker is placed on the signal having a frequency that is closest to the <expected\_value> parameter. Default units for <expected\_value> parameter are in Hz. When used with an :ARRay command, an array of frequencies is returned. The display is placed in the list-by-wavelength mode.

The <resolution> parameter sets the resolution of the measurement. It is a unitless number whose value will be limited to either 0.01 or 0.001 (whichever is closer). MAXimum resolution is equivalent to the FAST measurement update mode. MINimum resolution is equivalent to the NORMAL measurement update mode.

Returned values are in Hz (display is in THz). Power units are not affected.

#### CONFigure command

When this function is used with the CONFigure command, the query question mark character "?" *must not* be included in the string. However, the FETCh, READ, and MEASure command are queries and require the question mark. Refer to the examples for this command.

### <expected\_value> Constants

MAXimum	The highest frequency signal
MINimum	The lowest frequency signal

	DEFault	The current marker position
<b>&lt;resolution&gt; Constants</b>	MAXimum	0.01 resolution (fast update)
	MINimum	0.001 resolution (normal)
	DEFault	Current resolution

**Examples**

```
:CONF:ARR:POW:FREQ DEF MIN
:FETC:ARR:POW:FREQ? DEF MAX
:READ:ARR:POW:FREQ?
:MEAS:ARR:POW:FREQ?

:CONF:SCAL:POW:FREQ 230.8THZ, MAX
:FETC:SCAL:POW:FREQ? 230.8THZ, MIN
:READ:SCAL:POW:FREQ? 230.8THZ
:MEAS:SCAL:POW:FREQ? 230.8THZ
```

**Query Response**

The following line is an example of a returned string when :MEAS:SCAL:POW:FREQ? MAX is sent:

```
+1.94055176E+014
```

If six laser lines are located and :MEAS:ARR:POW:FREQ? is sent, the following string is an example of the returned data. Notice that the first returned number indicates the number of laser-line values returned in the query.

```
6, +1.94055100E+014, +1.93854100E+014, +1.93653000E+014, +1.93452000E+014, +1.93250900E+014, +1.93050000E+014
```

## MEASure{:ARRay | [:SCALar]} :POWer:WAVelength

Returns wavelength values.

### Syntax

```
:POWer:WAVelength? [<expected_value>[, <resolution>]]
```

Used With	<expected_value>	<resolution>
SCALar	optional	optional
ARRay	ignored <sup>a</sup>	optional

- a. Although ignored, this argument must be present if the resolution argument is specified.

### Description

When used with a :SCALar command, a single value is returned. The display is placed in the single-wavelength mode, and the marker is placed on the signal having a wavelength that is closest to the <expected\_value> parameter. Default units for <expected\_value> parameter are in meters.

When used with an :ARRay command, an array of wavelengths is returned. The display is placed in the list-by-wavelength mode.

The <resolution> parameter sets the resolution of the measurement. It is a unitless number whose value will be limited to either 0.01 or 0.001 (whichever is closer).

Returned values are in meters. Displayed units are nanometers. Power units are not affected.

#### **CONFigure command**

When this function is used with the CONFigure command, the query question mark character "?" *must not* be included in the string. However, the FETCh, READ, and MEASure command are queries and require the question mark. Refer to the examples for this command.

<b>&lt;expected_value&gt; Constants</b>	MAXimum	The highest wavelength signal
	MINimum	The lowest wavelength signal



	DEFault	The current marker position
<b>&lt;resolution&gt; Constants</b>	MAXimum	0.01 resolution (fast update)
	MINimum	0.001 resolution (normal)
	DEFault	Current resolution

**Examples**

```
:CONF:ARR:POW:WAV DEF MAX
:FETC:ARR:POW:WAV? DEF MIN
:READ:ARR:POW:WAV?
:MEAS:ARR:POW:WAV?

:CONF:SCAL:POW:WAV 1300NM, MAX
:FETC:SCAL:POW:WAV? 1300NM, MIN
:READ:SCAL:POW:WAV? 1300NM
:MEAS:SCAL:POW:WAV? 1300NM
```

**Query Response**

The following line is an example of a returned string when  
:MEAS:SCAL:POW:WAV? MAX is sent:

```
+1.5529258E-006
```

If six laser lines are located and :MEAS:ARR:POW:WAV? is sent, the following string could be returned. Notice that the first returned number indicates the number of laser-line values returned in the query.

```
6, +1.54488100E-006, +1.54648400E-006, +1.54809000E-006, +1.54969900E-006, +1.55131100E-006, +1.55292600E-006
```

## MEASure{:ARRay | [:SCALar]} :POWER:WNUMBER

Returns a wave number value.

### Syntax

```
:POWER:WNUMBER? [<expected_value>[,<resolution>]]
```

Used With	<expected_value>	<resolution>
SCALar	optional	optional
ARRay	ignored <sup>a</sup>	optional

- a. Although ignored, this argument must be present if the resolution argument is specified.

### Description

When used with a :SCALar command, a single value is returned. The display is placed in the single-wavelength mode, and the marker is placed on the signal having a wave number that is closest to the <expected\_value> parameter. Default units for <expected\_value> parameter are in  $m^{-1}$ .

When used with an :ARRay command, an array of wave number is returned. The display is placed in the list-by-wavelength mode.

The <resolution> parameter sets the resolution of the measurement. It is a unitless number whose value will be limited to either 0.01 or 0.001 (whichever is closer).

Returned values are in inverse meters. Displayed units are inverse centimeters. Power units are not affected.

#### CONFigure command

When this function is used with the CONFigure command, the query question mark character "?" *must not* be included in the string. However, the FETCH, READ, and MEASure command are queries and require the question mark. Refer to the examples for this command.

### <expected\_value> Constants

MAXimum	The laser line having the largest wave number
MINimum	The laser line having the smallest wave number

	DEFault	The current marker position
<b>&lt;resolution&gt; Constants</b>	MAXimum	0.01 resolution (fast update)
	MINimum	0.001 resolution (normal)
	DEFault	Current resolution

**Examples**

```
:CONF:ARR:POW:WNUM DEF MAX
:FETC:ARR:POW:WNUM? DEF MIN
:READ:ARR:POW:WNUM?
:MEAS:ARR:POW:WNUM?
:CONF:SCAL:POW:WNUM 6451, MAX
:FETC:SCAL:POW:WNUM? 6451, MIN
:READ:SCAL:POW:WNUM? 6451
:MEAS:SCAL:POW:WNUM? 6451
```

**Query Response** If the :MEAS:SCAL:POW:WNUM? 6451 command is sent, and a 1550 nm laser line is present, the following response would be returned to the computer:

```
+6.45286262E+005
```

Notice that the returned units are  $m^{-1}$ . If six laser lines are measured and :MEAS:ARR:POW:WNUM? is sent, the following response is returned. Notice that the first returned number indicates the number of laser-line values returned in the query.

```
6, +6.47298400E+005, +6.46627900E+005, +6.45957000E+005, +6.45286300E+005, +6.44615600E+005, +6.43945300E+005
```

### MEASure[:SCALar]:LENGth:COHerence:ALPHa?

Queries the alpha constant.

**Syntax** :LENGth:COHerence:ALPHa?

**Attribute Summary** Query Only

**Description** The alpha constant is a unitless ratio.

Programming Commands  
**Measurement Instructions**

---

**MEASure[:SCALar]:LENGth:COHerence:BETA?**

Queries the beta constant.

**Syntax** :LENGth:COHerence:BETA?

**Attribute Summary** Query Only

**Description** The beta constant is a unitless ratio.

---

**MEASure[:SCALar]:LENGth:COHerence[:CLENGth]?**

Queries the coherence length of the input signal in meters.

**Syntax** :LENGth:COHerence:CLENGth?

**Attribute Summary** Query Only

---

**MEASure[:SCALar]:LENGth:COHerence:DELAy?**

Queries the round-trip path delay in the laser chip.

**Syntax** :LENGth:COHerence:DELAy?

**Attribute Summary** Query Only

**Description** The units of the returned value are in meters.

---

## CALCulate1 Subsystem

Use the CALCulate1 commands to query *uncorrected* frequency-spectrum data. In *NORMAL* measurement update mode, 34,123 values are returned. If the HP 86120B is set for *FAST* measurement update mode (low resolution), 4,268 values are returned.

The commands in this subsystem have the following command hierarchy:

```
:CALCulate1
  :DATA?
  :TRANSform
    :FREQuency
    :POINts
```

## DATA?

Queries *uncorrected* frequency-spectrum data of the input laser line.

**Syntax** :CALCulate1:DATA?

**Attribute Summary** Preset State: not affected  
SCPI Compliance: standard  
Query Only

**Description** The returned values are in squared Watts (linear) units. No amplitude or frequency correction is applied to the values. To obtain the logarithmic result, multiply five times the logarithm of the returned values.

Be prepared to process a large amount of data when this query is sent. The amount of data returned depends on the measurement update state of the instrument which can be set using the :CALCulate1:TRANSform:FREQuency:POINts command or the resolution argument of an instrument function. Refer to "Measurement Instructions" on page 4-16.

When *NORMAL* measurement update is specified, over 580 kilobytes of data (34,123 values) can be returned to the computer. When *FAST* measurement update is specified, over 72 kilobytes of data (4,268 values) can be returned.

The following string is a typical example of the first few returned values:

```
+4.02646500E+001,+6.78125100E+001,+6.17986600E+001,+4.26768200  
E+001,-4.80245300E+001,+3.10491300E-001,+1.13409400E+001,+5.07  
832500E+001,+2.77746200E+001,+3.89150500E+001,+3.50217600E+001  
,+7.34649800E-001,+5.64983800E+000,
```

Notice that only measurement values are returned to the computer. There is no first value that indicates the number of values contained in the string as there is, for example, with the FETCh, READ, and MEASure commands. Use the :CALCulate1:TRANSform:FREQuency:POINts command to query the number of points the :CALC1:DATA? returns.

When *NORMAL* measurement mode is selected, the uncorrected frequency domain data consists of 64K (65,536) values. Only the frequency domain data corresponding to 700-1650 nm wavelength (in vacuum) is returned (34,123 values). In *FAST* measurement mode, the data consists of 8K (8,192) values of which 4,268 values are returned.

The frequency spacing between values is uniform and is equal to the reference laser frequency (473.6127 THz) divided by 64K, or 7.226756 GHz. Note the spacing between values is not uniform in wavelength units. The values returned are in ascending optical frequency.

The first value of the uncorrected frequency data corresponds to an optical frequency of 181.6879 THz (1650.041 nm). The last value of the uncorrected frequency data corresponds to an optical frequency of 428.2793 THz (699.993 nm). For example, a laser line peak located at the 1,500th returned value has an optical frequency of:

$$\begin{aligned} \text{frequency} &= 181.6879 \text{ THz} + 1,499(7.226756 \text{ GHz}) \\ &= 192.5208 \text{ THz} \end{aligned}$$

or, 1557.195 nm (in vacuum).

When *FAST* measurement mode is selected, the uncorrected frequency domain data consists of 8K (8,192) values. The frequency spacing between elements is uniform and is equal to the reference laser frequency (473.6127 THz) divided by 8K, or 57.81405 GHz. Note the spacing between values is not uniform in wavelength units. The values returned are in ascending optical frequency. Only the frequency domain data corresponding to 700-1650 nm wavelength (in vacuum) is returned (4,268 values). The first value of the uncorrected frequency data corresponds to an optical frequency of 181.652 THz (1650.37 nm). The last value of the uncorrected frequency data corresponds to an optical frequency of 428.344 THz (699.89 nm). For example, a laser line peak located at the 200th returned value has an optical frequency of:

$$\begin{aligned} \text{frequency} &= 181.652 \text{ THz} + 199(57.81405 \text{ GHz}) \\ &= 193.157 \text{ THz} \end{aligned}$$

or, 1551.07 nm (in vacuum).

If your program is aborted or interrupted after sending this query, the HP 86120B continues to process the data but does not place it in the output buffer. Because of the amount of data processed, the instrument will not respond to any new commands in its input buffer for up to 20 seconds.

This query will generate a "Settings conflict" error if the instrument is in either the coherence length or the signal-to-noise average application.

---

## TRANSform:FREQuency:POINts

Sets the size of the fast Fourier transform (FFT) performed by the instrument.

**Syntax** :CALCulate1:TRANSform:FREQuency:POINts{?! {<integer> | MINimum | MAXimum}}

<integer> Sets FFT size. Must be either 34123 or 4268. Other values result in an error.

<u>Constant</u>	<u>Description</u>
MINimum	4,268
MAXimum	34,123

**Attribute Summary** Non-sequential command  
Preset State: array size set to 34,123  
\*RST State: 34,123  
SCPI Compliance: instrument specific

**Description** A *NORMAL* updated display corresponds to an FFT size of 34,123. A *FAST* updated display corresponds to an FFT size of 4,268. These values are a subset of the uncorrected-data buffer shown in the figure that is located in "Making Measurements" on page 3-6. Changing the number of points causes the instrument to reprocess the current set of data.

The query form of the command returns the number of points in the data set. This is the number of measurement points that will be returned by the CALC1:DATA? query.

### **Non-sequential command**

Always use an \*OPC? query or a \*WAI command to ensure that this command has the time to complete before sending any more commands to the instrument. Refer to "Always force the HP 86120B to wait for non-sequential commands" on page 3-13 for more information.



**Query Response**      For normal update:  
                                 +34123  
                                 For fast update:  
                                 +4268

## CALCulate2 Subsystem

Use the CALCulate2 commands to query *corrected* values frequency-spectrum data.

The commands in this subsystem have the following command hierarchy:

```
:CALCulate2
  :DATA?
  :PEXCursion
  :POINTs?
  :PTHReshold
  :PWAVerage
    [:STATe]
  :WLIMit
    [:STATe]
  :START
    :FREQuency
    [:WAVelength]
    :WNUMber
  :STOP
    :FREQuency
    [:WAVelength]
    :WNUMber
```

## DATA?

Queries the corrected peak data of the input laser line.

**Syntax** :CALCulate2:DATA? {FREQuency | POWer | WAVelength | WNUMber}

<u>Constant</u>	<u>Description</u>
FREQuency	Queries the array of laser-line frequencies after the peak search is completed. If :CALC2:PWAV:STAT is on, the power-weighted average frequency is returned.
POWer	Queries the array of laser-line powers after the peak search is completed. If :CALC2:PWAV:STAT is on, the total input power is returned.
WAVelength	Queries the array of laser-line wavelengths after the peak search is completed. If :CALC2:PWAV:STAT is on, the power-weighted average wavelength is returned.
WNUMber	Queries the array of laser-line wave numbers after the peak search is completed. If :CALC2:PWAV:STAT is on, the power-weighted average wave number is returned.

**Attribute Summary**

- Preset State: not affected
- SCPI Compliance: standard
- Query Only

**Description** Use the CALC2:POIN? query to determine the number of points the CALC2:DATA? query will return. The following string is a typical example of the first few returned values returned when WAVelength is specified:

```
+1.54488600E-006, +1.54649100E-006, +1.54808300E-006, +1.54969600E-006, +1.55131200E-006, +1.55293000E-006
```

This next string resulted by specifying the WNUMber argument:

```
+6.47296600E+005, +6.46625000E+005, +6.45959900E+005, +6.45287500E+005, +6.44615500E+005, +6.43943900E+005
```

Notice that only measurement values are returned to the computer. There is no first value that indicates the number of values contained in the string as there is, for example, with the FETCh, READ, and MEASure commands.

Programming Commands  
**CALCulate2 Subsystem**

When there is no input signal, the POWER query returns -200 dBm; the WAVElength query returns 100 nm (1.0E-7).

---

## PEXCursion

Sets the peak excursion limit used by the HP 86120B to determine valid laser line peaks.

**Syntax** :CALCulate2:PEXCursion{?| (<integer> | MINimum | MAXimum | DEFault)}

<integer> represents logarithmic units in dB. Valid range is 1 to 30 dB.

<u>Constant</u>	<u>Description</u>
MINimum	1 dB
MAXimum	30 dB
DEFault	15 dB

**Attribute Summary** Non-sequential command  
Preset State: 15 dB  
\*RST State: 15 dB  
SCPI Compliance: instrument specific

**Description** A laser line is identified as a valid peak if its amplitude is greater than the peak excursion plus the amplitudes of the closest local minima on either side of the peak. This command works in conjunction with the peak threshold setting. Refer to "PTHReshold" on page 4-35. Changing the peak excursion limit causes the instrument to reprocess the current set of data. Refer also to "Defining Laser-Line Peaks" on page 2-15.

The query response is the current value. For example, if the current value is set to 15 dB, the following value is returned:

15

**Non-sequential command**

Always use an \*OPC? query or a \*WAI command to ensure that this command has the time to complete before sending any more commands to the instrument. Refer to "Always force the HP 86120B to wait for non-sequential commands" on page 3-13 for more information.

---

## POINTs?

Queries the number of points in the data set.

**Syntax** :CALCulate2:POINTs?

**Attribute Summary** Preset State: unaffected  
\*RST State: unaffected  
SCPI Compliance: instrument specific  
Query Only

**Description** This is the number of points that will be returned by the CALC2:DATA? query.

**Query Response** For example, if six laser lines are located:  
+6

---

## PTHReshold

Sets the peak threshold limit used by the instrument to determine valid laser line peaks.

**Syntax** :CALCulate2:PTHReshold{?| (<integer> | MINimum | MAXimum | DEFault)}

<integer> represents logarithmic units in dB. Valid range is 0 to 40.

Programming Commands

**CALCulate2 Subsystem**

<u>Constant</u>	<u>Value</u>
MINimum	0 dB
MAXimum	40 dB
DEFault	10 dB

**Attribute Summary**      Non-sequential command  
Preset State: 10 dB  
\*RST State: 10 dB  
SCPI Compliance: instrument specific

**Description**            A laser line is identified as a valid peak if its amplitude is above the maximum amplitude minus the peak threshold value. The subtraction is done in dB units. This setting works in conjunction with the peak excursion setting to determine which responses are located. Refer to "PEXCursion" on page 4-34. Changing the peak threshold limit causes the instrument to reprocess the current set of data. Refer also to "Defining Laser-Line Peaks" on page 2-15.

The query response is the current value. For example, if the current value is set to 15 dB, the following value is returned:

15

**Non-sequential command**

Always use an \*OPC? query or a \*WAI command to ensure that this command has the time to complete before sending any more commands to the instrument. Refer to "Always force the HP 86120B to wait for non-sequential commands" on page 3-13 for more information.

---

**PWAVerage[:STATE]**

Places the instrument in the power-weighted average mode.

**Syntax**                    :CALCulate2:PWAVerage[:STATE]{?| {ON | OFF | 1 | 0}}

**Attribute Summary**      Preset State: off  
\*RST State: off

**Description** When the state is on, the CALC2:DATA? POW query returns the total power and the CALC2:DATA? WAV, FREQ, or WNUM query returns the power-weighted average wavelength, frequency, or wave number values.

Turning power-weighted average mode on while making delta, coherence length, or signal-to-noise measurements results in a “-221 Settings conflict” error.

---

## WLIMit[::STATe]

Limits input wavelength range of the HP 86120B.

**Syntax** :CALCulate2:WLIMit[::STATe] {? | (ON | OFF | 1 | 0)}

**Attribute Summary** Non-sequential command  
Preset State: on  
\*RST State: on  
SCPI Compliance: instrument specific

**Description** When this function is on, the HP 86120B has an input range from the WLIMit START to the WLIMit STOP. When this function is off, the instrument displays peaks over the full wavelength range. If you want to measure signals over a narrower wavelength range, set this function on to avoid identifying spurious second harmonic peaks.

Whenever the HP 86120B receives this command, it reprocesses the data and performs a new peak search.

### **Non-sequential command**

Always use an \*OPC? query or a \*WAI command to ensure that this command has the time to complete before sending any more commands to the instrument. Refer to “Always force the HP 86120B to wait for non-sequential commands” on page 3-13 for more information.

## WLIMit:STARt:FREQuency

Sets the starting frequency for the wavelength limit range.

**Syntax** :CALCulate2:WLIMit:STARt:FREQuency {?|(<real> | MINimum | MAXimum )}  
<real> is a frequency value that is within the following limits:

<u>Constant</u>	<u>Description</u>
MINimum	181.6924 THz
MAXimum	wavelength limit stop value

**Attribute Summary** Non-sequential command  
Preset State: 181.6924 THz  
\*RST State: 181.6924 THz  
SCPI Compliance: instrument specific

**Description** This command sets the starting range for the wavelength limit in Hertz. The start frequency value must be less than or equal to the stop frequency value or the start frequency will be clipped to the stop frequency and a "Data out of range" error will be generated. The default units for the <real> parameter are hertz.

### **Non-sequential command**

Always use an \*OPC? query or a \*WAI command to ensure that this command has the time to complete before sending any more commands to the instrument. Refer to "Always force the HP 86120B to wait for non-sequential commands" on page 3-13 for more information.



## WLIMit:START[:WAVelength]

**Syntax**                    CALCulate2:WLIMit:START[:WAVelength] {?|(<real> | MINimum | MAXimum)}

<real> is a wavenumber value that is within the following limits:

<u>Constant</u>	<u>Description</u>
MINimum	700.0 nm
MAXimum	wavelength limit stop value

**Attribute Summary**        Non-sequential command  
Preset State: 700 nm  
\*RST State: 700 nm  
SCPI Compliance: instrument specific

**Description**                This command sets the starting range for the wavelength limit. The start wavelength value must be less than or equal to the stop wavelength value or the start wavelength will be clipped to the stop wavelength and a “Data out of range” error will be generated. Setting the start wavelength is equivalent to setting the stop frequency/wavenumber because of the inverse relationship of frequency to wavelength. The default units for the <real> parameter are meters.

**Non-sequential command**

Always use an \*OPC? query or a \*WAI command to ensure that this command has the time to complete before sending any more commands to the instrument. Refer to “Always force the HP 86120B to wait for non-sequential commands” on page 3-13 for more information.

## WLIMit:STARt:WNUMber

Sets the starting wavenumber for the wavelength limit range.

**Syntax** :CALCulate2:WLIMit:STARt:WNUMber {?|(<real> | MINimum | MAXimum)}  
<real> is a wavenumber value that is within the following limits:

<u>Constant</u>	<u>Description</u>
MINimum	6060 cm <sup>-1</sup>
MAXimum	wavelength limit stop value

**Attribute Summary** Non-sequential command  
Preset State: 6.060606E5 m<sup>-1</sup>  
\*RST State: 6.060606E5 m<sup>-1</sup>  
SCPI Compliance: instrument specific

**Description** This command sets the starting range for the wavelength limit. The default units for the <real> parameter value are m<sup>-1</sup>. The start wavenumber value must be less than or equal to the stop wavenumber value or the start wavenumber will be clipped to the stop wavenumber and a "Data out of range" error will be generated.

### **Non-sequential command**

Always use an \*DPC? query or a \*WAI command to ensure that this command has the time to complete before sending any more commands to the instrument. Refer to "Always force the HP 86120B to wait for non-sequential commands" on page 3-13 for more information.

## WLIMit:STOP:FREQuency

Sets the stopping frequency for the wavelength limit range.

**Syntax** :CALCulate2:WLIMit:STOP:FREQuency {?|(<real> | MINimum | MAXimum )}

<real> is a frequency value that is within the following limits:

<u>Constant</u>	<u>Description</u>
MINimum	start wavelength limit
MAXimum	428.2750 THz

**Attribute Summary**

- Non-sequential command
- Preset State: 249.8271 THz
- \*RST State: 249.8271 THz
- SCPI Compliance: instrument specific

**Description** This command sets the stopping range for the wavelength limit. The default units for the <real> parameter are Hz. The stop frequency value must be greater than or equal to the start frequency value or the stop frequency will be clipped to the start frequency and a "Data out of range" error will be generated.

**Non-sequential command**

Always use an \*OPC? query or a \*WAI command to ensure that this command has the time to complete before sending any more commands to the instrument. Refer to "Always force the HP 86120B to wait for non-sequential commands" on page 3-13 for more information.

## WLIMit:STOP[:WAVelength]

Sets the stopping wavelength for the wavelength limit range.

**Syntax** :CALCulate2:WLIMit:STOP[WAVelength] {?|<real> | MINimum | MAXimum }

<real> is a wavelength value that is within the following limits:

<u>Constant</u>	<u>Description</u>
MINimum	start wavelength limit
MAXimum	1650.0 nm

**Attribute Summary** Non-sequential command  
Preset State: 1650 nm  
\*RST State: 1650 nm  
SCPI Compliance: instrument specific

**Description** This command sets the stopping range for the wavelength limit. The default units for the <real> parameter are meters. The stop wavelength value must be greater than or equal to the start wavelength value or the stop wavelength will be clipped to the start wavelength and a "Data out of range" error will be generated. Setting the start wavelength is equivalent to setting the start frequency/wavenumber because of the inverse relationship of frequency to wavelength.

**Non-sequential command**

Always use an \*OPC? query or a \*WAI command to ensure that this command has the time to complete before sending any more commands to the instrument. Refer to "Always force the HP 86120B to wait for non-sequential commands" on page 3-13 for more information.

## WLIMit:STOP:WNUMBER

Sets the stopping wavenumber for the wavelength limit range.

### Syntax

```
:CALCulate2:WLIMit:STOP:WNUMBER {?|(<real> | MINimum | MAXimum )}
```

<real> is a wavenumber value that is within the following limits:

<u>Constant</u>	<u>Description</u>
MINimum	start wavelength limit
MAXimum	14286 cm <sup>-1</sup> (700 nm)

### Attribute Summary

Non-sequential command  
Preset State: 8.333335E5 m<sup>-1</sup>  
\*RST State: 8.333335E5 m<sup>-1</sup>  
SCPI Compliance: instrument specific

### Description

This command sets the stopping range for the wavelength limit. The default units for the <real> parameter are inverse meters. The stop wavenumber value must be less than or equal to the start wavenumber value or the stop wavenumber will be clipped to the start wavenumber and a "Data out of range" error will be generated.

#### **Non-sequential command**

Always use an \*OPC? query or a \*WAI command to ensure that this command has the time to complete before sending any more commands to the instrument. Refer to "Always force the HP 86120B to wait for non-sequential commands" on page 3-13 for more information.

---

## CALCulate3 Subsystem

Use the CALCulate3 commands to perform delta, drift, and signal-to-noise measurements. The commands in this subsystem have the following command hierarchy:

```
:CALCulate3
:ASNR
:CLEAr
:COUNT
[:STATe]
:DATA?
:DELTA
:POWER
[:STATe]
:PRESet
:REFerence
:FREQuency
:POWer?
[:WAVelength]
:WNUMber
:WAVelength
[:STATe]
:WPOWer
[:STATe]
:DRIFT
:DIFFerence
[:STATe]
:MAXimum
[:STATe]
:MINimum
[:STATe]
:PRESet
:REFerence
:RESet
[:STATe]
[:STATe]
:POINTs?
:PRESet
:SNR
:AUTO
:REFerence
:FREQuency
[:WAVelength]
:WNUMber
[:STATe]
```

## ASNR:CLEar

Clears the number of measurements used in the average signal-to-noise calculation.

**Syntax**                   :CALCulate3:ASNR:CLEar

**Attribute Summary**       Preset State: not affected  
                              \*RST State: not affected  
                              SCPI Compliance: instrument specific

**Description**             This command clears the number of measurements used in the average signal-to-noise calculation. The current measurement is used as the new reference for the average signal-to-noise calculation.

## ASNR:COUNT

Sets the number of measurements to be used for the average signal-to-noise calculation.

**Syntax**                   :CALCulate3:ASNR:COUNT {?|<integer> | MINimum | MAXimum }

<integer> is a value that is within the following limits:

<u>Constant</u>	<u>Description</u>
MINimum	10
MAXimum	900

**Attribute Summary**       Preset State: 100  
                              \*RST State: 100  
                              SCPI Compliance: instrument specific

**Description**             This command sets the number of measurements to be used for the average signal-to-noise calculation. If this count is changed while the average signal calculation is on, and the new count is less than the number of measurements already taken, the instrument will go into single measurement mode.



---

## ASNR[:STATe]

Turns the average signal-to-noise ratio on or off.

**Syntax** :CALCulate3:ASNR[:STATe] {?|{ ON | OFF | 1 | 0 }}

**Attribute Summary**      Preset State: off  
                             \*RST State: off  
                             SCPI Compliance: instrument specific

**Description**            This command turns the average signal-to-noise calculation on or off. Only one of the CALCulate3 calculations (ASNR, DELTA, DRIFT, or SNR) can be turned on at a time. Turning on the ASNR calculation while another calculation is on will generate a "Settings conflict" error.

When the calculation is first turned on, the lines measured in the current measurement will be used as the reference values for the signal-to-noise ratio. Subsequent measurements will average the noise values. The signal values are not updated until the number of measurements used to average the noise is greater than or equal to the COUNT value.

**Note**

Only one STATE command can be turned on at any one time. Attempting to turn more than one state on at a time results in a "-221 Settings Conflict" error. Refer to "Measure delta, drift, and signal-to-noise" on page 3-15 for additional information on selecting measurements.

## DATA?

Queries the data resulting from delta, drift, and signal-to-noise measurements.

**Syntax** :CALCulate3:DATA? {POWER | FREQUENCY | WAVELENGTH | WNUMBER}

<u>Argument</u>	<u>Description</u>
POWER	Queries the array of laser-line powers after the calculation is completed.
FREQUENCY	Queries the array of laser-line frequencies after the calculation is completed.
WAVELENGTH	Queries the array of laser-line wavelengths after the calculation is completed.
WNUMBER	Queries the array of laser-line wave numbers after the calculation is completed.

**Attribute Summary** Preset State: not affected  
SCPI Compliance: standard  
Query Only

**Description** The data returned by the query depends upon which calculation state is on. If no calculation state is on, an error is generated. The returned data is comma delimited. The following string is a typical example of six values returned when POWER is specified from a delta power measurement:

```
-7.42833100E+000, -1.00087200E+000, -2.52121400E+000,  
-3.41918900E+000, -3.80437200E+000, -6.36282900E+000
```

Notice that only measurement values are returned to the computer. There is no first value that indicates the number of values contained in the string as there is, for example, with the FETCH, READ, and MEASURE commands. Use the CALC3:POIN? query to determine the number of points the CALC3:DATA? query returns.

In the SNR or ASNR calculation, only the POWER argument is valid. The other arguments will generate a "Settings conflict" error. Use the CALC2:DATA? query to retrieve the signal wavelengths and powers.

---

## DELTA:POWer[:STATe]

Turns the delta-power measurement mode on and off.

**Syntax** :CALCulate3:DELTA:POWer[:STATe]{?! {ON | OFF | 1 | 0}}

**Attribute Summary** Preset State: off  
\*RST State: off  
SCPI Compliance: instrument specific

**Description** When this state is on, the power of the reference laser line is subtracted from the power values of all laser lines except the reference.

The power data returned by the CALC3:DATA? query is the array of laser line power levels normalized to the power level of the reference laser line. The power of the reference laser line is returned as an absolute power (unnormalized). The frequency data returned is the array of absolute frequency values.

**Note**

Only one STATE command can be turned on at any one time. Attempting to turn more than one state on at a time results in a "-221 Settings Conflict" error. Refer to "Measure delta, drift, and signal-to-noise" on page 3-15 for additional information on selecting measurements.

---

## DELTA:PRESet

Turns off all delta measurement states.

**Syntax** :CALCulate3:DELTA:PRESet

**Attribute Summary** Preset State: not affected  
\*RST State: not affected  
SCPI Compliance: instrument specific  
Command Only

## DELTA:REFerence:FREQuency

Selects the reference laser line for DELTA calculations.

**Syntax** :CALCulate3:DELTA:REFerence:FREQuency(?| (<real> | MINimum | MAXimum))

<real> is a frequency value that is within the following limits:

<u>Constant</u>	<u>Description</u>
MINimum	181.6924 THz
MAXimum	428.6 THz

**Attribute Summary** Preset State: 428.6 THz (700 nm)  
\*RST State: 428.6 THz (700 nm)  
SCPI Compliance: instrument specific

**Description** The reference will be the laser line at the frequency closest to the frequency entered. Subsequent measurements will use the frequency closest to the reference frequency used for the previous measurement.

The query returns the reference laser line's frequency. The default units for the <real> parameter are Hz.

---

## DELTA:REFerence:POWer?

Queries the reference laser line's power level.

**Syntax** :CALCulate3:DELTA:REFerence:POWer?

**Attribute Summary** Preset State: not affected  
\*RST State: not affected  
SCPI Compliance: instrument specific  
Query Only

---

## DELTA:REFERENCE[:WAVElength]

Selects the reference laser line for DELTA calculations.

### Syntax

```
:CALCulate3:DELTA:REFERENCE[:WAVElength]{?| {<real> | MINimum | MAXimum}}
```

<real> is a wavelength value that is within the following limits:

<u>Constant</u>	<u>Description</u>
MINimum	700.0 nm
MAXimum	1650.0 nm

### Attribute Summary

Preset State: 700 nm (428.6 THz)  
 \*RST State: 700 nm (428.6 THz) laser line  
 SCPI Compliance: instrument specific

### Description

The reference will be the laser line at the wavelength closest to the wavelength entered. Subsequent measurements will use the wavelength closest to the reference wavelength used for the previous measurement.

The query returns the current wavelength of the reference laser line. The default units for the <real> parameter are meters.

## DELTA:REFERENCE:WNUMBER

Selects the reference laser line for delta calculations.

**Syntax** :CALCulate3:DELTA:REFERENCE:WNUMBER{?| (<real> | MINimum | MAXimum)}

<real> is a wave number value that is within the following limits:

<u>Constant</u>	<u>Description</u>
MINimum	6,061 cm <sup>-1</sup>
MAXimum	14,286 cm <sup>-1</sup>

**Attribute Summary** Preset State: 14,286 cm<sup>-1</sup> (700 nm)  
\*RST State: 14,286 cm<sup>-1</sup> (700 nm)  
SCPI Compliance: instrument specific

**Description** The reference will be the laser line at the wave number closest to the wave number entered. Subsequent measurements will use the wave number closest to the reference wave number used for the previous measurement.

The query returns the current wave number of the reference laser line. The default units for the <real> parameter are m<sup>-1</sup>.

---

## DELTA:WAVelength[:STATe]

Turns the delta wavelength measurement mode on and off.

**Syntax** :CALCulate3:DELTA:WAVelength[:STATe]{?| {ON | OFF | 1 | 0}}

**Attribute Summary** Preset State: off  
\*RST State: off  
SCPI Compliance: instrument specific

**Description** When on, the wavelength of the reference laser line is subtracted from the wavelength values of all laser lines except the reference.

For the CALC3:DATA? query, the power data returned is the array of absolute powers measured for each laser line. The frequency data is the array of frequency values normalized to the frequency of the reference laser line. The frequency of the reference laser line is returned as an absolute frequency (unnormalized).

**Note**

Only one STATE command can be turned on at any one time. Attempting to turn more than one state on at a time results in a “-221 Settings Conflict” error. Refer to “Measure delta, drift, and signal-to-noise” on page 3-15 for additional information on selecting measurements.

## DELTA:WPOWER[:STATE]

Turns the delta wavelength and power measurement mode on and off.

**Syntax** :CALCulate3:DELTA:WPOWER[:STATE]{?| (ON | OFF | 1 | 0)}

**Attribute Summary**      Preset State: off  
                             \*RST State: off  
                             SCPI Compliance: instrument specific

**Description**            When on, the wavelength of the reference laser line is subtracted from the wavelength values of all laser lines except the reference. The power value of the reference is subtracted from the power values of all laser lines except the reference.

For the CALC3:DATA? query, the power data returned is the array of powers normalized to the power of the reference laser line. The power of the reference laser line is returned as an absolute power (unnormalized).

The frequency data is the array of frequency values normalized to the frequency of the reference laser line. The frequency of the reference laser line is returned as an absolute frequency (unnormalized).

**Note**

Only one STATE command can be turned on at any one time. Attempting to turn more than one state on at a time results in a "-221 Settings Conflict" error. Refer to "Measure delta, drift, and signal-to-noise" on page 3-15 for additional information on selecting measurements.



---

## DRIFt:DIFFerence[:STATe]

Sets the drift calculation to subtract the minimum values measured from the maximum values measured.

**Syntax** `:CALCulate3:DRIFt:DIFFerence[:STATe]{?| {ON | OFF | 1 | 0}}`

**Attribute Summary**      Preset State: off  
                             \*RST State: off  
                             SCPI Compliance: instrument specific

**Description**            Use the CALC3:DRIF:PRES command to turn off all the drift states before turning on this state. The CALC3:DATA? query returns the maximum power and frequency minus the minimum power and frequency.

### **Note**

Only one STATE command can be turned on at any one time. Attempting to turn more than one state on at a time results in a "-221 Settings Conflict" error. Refer to "Measure delta, drift, and signal-to-noise" on page 3-15 for additional information on selecting measurements.

## DRIFT:MAXimum[:STATe]

Sets the drift calculation to return the maximum power and frequency values measured.

**Syntax** :CALCulate3:DRIFT:MAXimum[:STATe]{?| {ON | OFF | 1 | 0}}

**Attribute Summary** Preset State: off  
\*RST State: off  
SCPI Compliance: instrument specific

**Description** Use the CALC3:DRIF:PRES command to turn off all the drift states before turning on this state. The CALC3:DATA? query returns the maximum power and frequency.

**Note**

Only one STATE command can be turned on at any one time. Attempting to turn more than one state on at a time results in a “-221 Settings Conflict” error. Refer to “Measure delta, drift, and signal-to-noise” on page 3-15 for additional information on selecting measurements.

---

## DRIFt:MINimum[:STATe]

Sets the drift calculation to return the minimum power and frequency values measured.

**Syntax** :CALCulate3:DRIFt:MINimum[:STATe]{?| {ON | OFF | 1 | 0}}

**Attribute Summary**      Preset State: off  
                             \*RST State: off  
                             SCPI Compliance: instrument specific

**Description**            Use the CALC3:DRIF:PRES command to turn off all the drift states before turning on this state. The CALC3:DATA? query returns the minimum power or frequency.

**Note**

Only one STATE command can be turned on at any one time. Attempting to turn more than one state on at a time results in a “-221 Settings Conflict” error. Refer to “Measure delta, drift, and signal-to-noise” on page 3-15 for additional information on selecting measurements.

## DRIFT:PRESet

Turns off all the drift states for DIFFerence, MAXimum, MINimum, and REFerence.

**Syntax** :CALCulate3:DRIFT:PRESet

**Attribute Summary** Preset State: unaffected by  
\*RST State: unaffected by  
SCPI Compliance: instrument specific  
Command Only

**Description** This command allows the CALC3:DATA? query to return the difference between the current measurement and the reference.

---

## DRIFT:REFerence:RESet

Places the current list of laser lines into the reference list.

**Syntax** :CALCulate3:DRIFT:REFerence:RESet

**Attribute Summary** Preset State: unaffected by  
\*RST State: unaffected by  
SCPI Compliance: instrument specific  
Command Only

---

## DRIFt:REFerence[:STATe]

Turns on and off the drift reference state.

**Syntax** :CALCulate3:DRIFt:REFerence[:STATe]{?| {ON | OFF | 1 | 0}}

**Attribute Summary** Preset State: off  
\*RST State: off  
SCPI Compliance: instrument specific

**Description** When this command is set to on, the CALC3:DATA? command returns the reference laser lines. Use the CALC3:DRIF:PRES command to turn off all the drift states before turning on the drift reference state.

**Note**

Only one STATE command can be turned on at any one time. Attempting to turn more than one state on at a time results in a "-221 Settings Conflict" error. Refer to "Measure delta, drift, and signal-to-noise" on page 3-15 for additional information on selecting measurements.

## DRIFT[:STATe]

Turns on and off the drift measurement calculation.

**Syntax** :CALCulate3:DRIFT[:STATe](?| {ON | OFF | 1 | 0})

**Attribute Summary** Preset State: off  
\*RST State: off  
SCPI Compliance: instrument specific

**Description** When the drift mode is first turned on, the current list of laser lines is placed into the reference. All subsequent measurements take the new data, subtract the reference data, and display the differences in wavelengths and powers.

The CALC3:DATA? query returns the power and frequency of the current measurement minus the power and frequency of the reference.

### **Note**

Only one STATe command can be turned on at any one time. Attempting to turn more than one state on at a time results in a "-221 Settings Conflict" error. Refer to "Measure delta, drift, and signal-to-noise" on page 3-15 for additional information on selecting measurements.

## POINTs?

Queries the number of points in the data set.

**Syntax** :CALCulate3:POINTs?

**Attribute Summary** Preset State: unaffected by  
RST State: unaffected by  
SCPI Compliance: instrument specific  
Query Only

**Description** The value returned is the number of points returned by the CALC3:DATA? query.

---

## PRESet

Turns off any CALCulate3 calculation that is on..

**Syntax** :CALCulate3:PRESet

**Attribute Summary** Preset State: unaffected by  
RST State: unaffected by  
SCPI Compliance: instrument specific  
Command Only

**Description** This command turns off any CALCulate3 calculation (delta, drift, signal-to-noise, or coherence length) that is on.

---

## SNR:AUTO

Selects the reference frequency value for measuring noise in the signal-to-noise calculation.

**Syntax** :CALCulate3:SNR:AUTO{?| {ON | OFF | 1 | 0}}

<u>Constant</u>	<u>Description</u>
ON	Selects internally generated reference frequency.
OFF	Selects user-entered reference frequency.

**Attribute Summary** Preset State: on  
\*RST State: on  
SCPI Compliance: instrument specific

**Description** The command argument allows you to select either an internally generated or a user-entered frequency reference for measuring the noise. To enter a value to use as the reference, use the SNR:REFerence:FREQuency, SNR:REFerence:WAVelength, and SNR:REFerence:WNUMber commands.



---

## SNR:REFerence:FREQuency

Enters a frequency that can be used for the noise measurement reference in signal-to-noise calculations.

### Syntax

```
:CALCulate3:SNR:REFerence:FREQuency{?| {<real> | MINimum | MAXimum}}
```

*<real>* is a frequency value that is within the following limits:

<u>Constant</u>	<u>Description</u>
MINimum	181.6924 THz
MAXimum	428.2750 THz

### Attribute Summary

Preset State: unaffected by  
\*RST State: 193.4145 THz (1550.0 nm in a vacuum).  
SCPI Compliance: instrument specific

### Description

After entering this value, use the SNR:AUTO command to configure the instrument to use this value in subsequent signal-to-noise calculations.

The default units for the *<real>* parameter are Hz.

## SNR:REFerence[:WAVelength]

Sets the wavelength used for the noise measurement reference in the signal-to-noise calculation.

**Syntax** :CALCulate3:SNR:REFerence[:WAVelength]{?! (<real> | MINimum | MAXimum)}

<real> is a wavelength value that is within the following limits:

<u>Constant</u>	<u>Description</u>
MINimum	700.0 nm
MAXimum	1650.0 nm

**Attribute Summary** Preset State: unaffected by  
\*RST State: 1550.0 nm in a vacuum.  
SCPI Compliance: instrument specific

**Description** After entering this value, use the SNR:AUTO command to configure the instrument to use this value in subsequent signal-to-noise calculations. The number entered is converted internally to the corresponding frequency.  
The default units for the <real> parameter are meters.

---

## SNR:REFerence:WNUMber

Sets the wave number used for the noise measurement reference in the signal-to-noise calculation.

**Syntax** :CALCulate3:SNR:REFerence:WNUMber{?! {<real> | MINimum | MAXimum} }

<real> is a wave number value that is within the following limits:

<u>Constant</u>	<u>Description</u>
MINimum	6060 cm <sup>-1</sup> (1650 nm)
MAXimum	14286 cm <sup>-1</sup> (700 nm)

**Attribute Summary** Preset State: unaffected by  
\*RST State: 6451.614 cm<sup>-1</sup>  
SCPI Compliance: instrument specific

**Description** After entering this value, use the SNR:AUTO command to configure the instrument to use this value in subsequent signal-to-noise calculations. The wave number entered is converted internally to the corresponding frequency.

The default units for the <real> parameter are m<sup>-1</sup>.

## SNR[:STATe]

Turns the signal-to-noise calculation on and off.

**Syntax** :CALCulate3:SNR[:STATe]{?| {ON | OFF | 1 | 0}}

**Attribute Summary**      Preset State: off  
                             \*RST State: off  
                             SCPI Compliance: instrument specific

**Note**

Only one STATe command can be turned on at any one time. Attempting to turn more than one state on at a time results in a "-221 Settings Conflict" error. Refer to "Measure delta, drift, and signal-to-noise" on page 3-15 for additional information on selecting measurements.

---

## CONFigure Measurement Instruction

For information on the CONFigure measurement instruction, refer to “Measurement Instructions” on page 4-16.

---

## DISPlay Subsystem

The commands in this subsystem have the following command hierarchy:

- :DISPlay
  - :MARKer:
    - :MAXimum
    - :LEFT
    - :NEXT
    - :PREVIOUS
    - :RIGHT
  - [:WINDow]
    - :GRAPHics
    - :STATE

---

## MARKer:MAXimum

Sets the marker to the laser line that has the maximum power.

**Syntax** :DISPlay:MARKer:MAXimum

**Attribute Summary** Preset State: marker set to maximum-power laser line  
\*RST State: marker set to maximum-power laser line  
SCPI Compliance: instrument specific  
Command Only

---

## MARKer:MAXimum:LEFT

Moves the marker left to the next laser line.

**Syntax** :DISPlay:MARKer:MAXimum:LEFT

**Attribute Summary** Preset State: marker set to maximum-power laser line  
\*RST State: marker set to maximum-power laser line  
SCPI Compliance: instrument specific  
Command Only

**Description** Moves the marker from the current marker position to the next laser line having the following characteristic:

- shorter wavelength
- lower frequency
- lower wave number

If the display is in the List by Ampl mode, it will be changed to List by WL before the marker is moved.

## **MARKer:MAXimum:NEXT**

Moves the marker to the laser line with the next lower power level.

**Syntax** :DISPlay:MARKer:MAXimum:NEXT

**Attribute Summary** Preset State: marker set to maximum-power laser line  
\*RST State: marker set to maximum-power laser line  
SCPI Compliance: instrument specific  
Command Only

**Description** If the display is in the List by WL mode, it will be changed to List by Ampl before the marker is moved.

---

## **MARKer:MAXimum:PREVIOUS**

Moves the marker to the laser line that has the next higher power level.

**Syntax** :DISPlay:MARKer:MAXimum:PREVIOUS

**Attribute Summary** Preset State: marker set to maximum-power laser line  
\*RST State: marker set to maximum-power laser line  
SCPI Compliance: instrument specific  
Command Only

**Description** If the display is in the List by WL mode, it will be changed to List by Ampl before the marker is moved.

---



---

## MARKer:MAXimum:RIGHT

Moves the marker right to the next laser line.

**Syntax** :DISPlay:MARKer:MAXimum:RIGHT

**Attribute Summary** Preset State: marker set to maximum-power laser line  
\*RST State: marker set to maximum-power laser line  
SCPI Compliance: instrument specific  
Command Only

**Description** Moves the marker from the current marker position to the next laser line having the following characteristic:

- longer wavelength
- higher frequency
- higher wave number

If the display is in the List by Ampl mode, it will be changed to List by WL before the marker is moved.

---

## [WINDow]:GRAPhics:STATe

Turns on and off the display of the power bars.

**Syntax** :DISPlay[:WINDow]:GRAPhics:STATe(?| {ON | OFF | 1 | 0})

**Attribute Summary** Preset State: on  
\*RST State: on  
SCPI Compliance: standard

**Description** Specifying on displays the power bars in all modes except the drift and signal-to-noise modes. Specifying off prevents the display of power bars for all instrument modes.

---

## FETCh Measurement Instruction

For information on the FETCh measurement instruction, refer to "Measurement Instructions" on page 4-16.

---

## HCOPy Subsystem

Use the command in this subsystem to print the displayed measurement results to a printer. This subsystem has the following command hierarchy:

```
:HCOPy  
  [:IMMediate]
```

---

### [:IMMediate]

Prints measurement results on a printer.

**Syntax**            :HCOPy:IMMediate

**Attribute Summary**    Preset State: none  
                         \*RST State: none  
                         SCPI Compliance: standard  
                         Command Only

**Description**        Connect the printer to the HP 86120B's rear-panel PARALLEL PRINTER PORT connector. The output to the printer is ASCII text.

Programming Commands

**MEASure Measurement Instruction**

---

## MEASure Measurement Instruction

For information on the MEASure measurement instruction, refer to “Measurement Instructions” on page 4-16.

---

## READ Measurement Instruction

For information on the READ measurement instruction, refer to “Measurement Instructions” on page 4-16.

## SENSe Subsystem

Use the SENSe commands to correct measurement results for elevation above sea level and to select between measurements in air or vacuum. You can also enter an amplitude offset. The commands in this subsystem have the following command hierarchy:

```
[:SENSe]
  :CORRection
  :ELEVations
  :MEDium
  :OFFSet
  [:MAGNitude]
  :DATA?
```

## CORRection:ELEVation

Sets the elevation value used by the instrument to compensate for air dispersion.

**Syntax** :SENSe:CORRection:ELEVation(?! (<integer> | MINimum | MAXimum))  
 <integer> is the altitude in meters.

<u>Constant</u>	<u>Description</u>
MINimum	0 m
MAXimum	5000 m

**Attribute Summar** Non-sequential command  
 Preset State: unaffected by  
 \*RST sets this value to the minimum.  
 SCPI Compliance: instrument specific

**Description** Changing the elevation value causes the current data to be reprocessed.

**Query Response** The query form returns the current elevation setting as shown in the following example:  
 +1500

**Non-sequential command**

Always use an \*OPC? query or a \*WAI command to ensure that this command has the time to complete before sending any more commands to the instrument. Refer to "Always force the HP 86120B to wait for non-sequential commands" on page 3-13 for more information.

## CORRection:MEDium

Sets the HP 86120B to return wavelength readings in a vacuum or standard air.

**Syntax** :SENSe:CORRection:MEDium{?! {AIR | VACuum}}

<u>Argument</u>	<u>Description</u>
AIR	Selects wavelength values in standard air.
VACuum	Selects wavelength values in a vacuum.

**Attribute Summary** Preset State: VAC  
\*RST State: VAC  
SCPI Compliance: instrument specific

**Description** Standard air is defined to have the following characteristics:  
Barometric pressure: 760 torr  
Temperature: 15°C  
Relative humidity: 0%



---

## CORRection:OFFSet[:MAGNitude]

Enters an offset for amplitude values.

**Syntax** :SENSe:CORRection:OFFSet:MAGNitude(?) {<real> | MINimum | MAXimum}

<real> is the logarithmic units in dB.

<u>Constant</u>	<u>Description</u>
MINimum	-40.0 dB
MAXimum	40.0 dB

**Attribute Summary** Preset State: 0.0  
\*RST State: 0.0  
SCPI Compliance: standard

**Query Response** The query form returns the current offset setting as shown in the following example:

-5.00000000E+000

## DATA?

Queries the time domain samples of the input laser line.

**Syntax** :SENSe:DATA?

**Attribute Summary** Preset State: none  
SCPI Compliance: instrument specific  
Query Only

**Description** Be prepared to process a large amount of data when this query is sent. The amount of data returned depends on the measurement update state of the instrument which is set using the resolution argument of an instrument function. Refer to "Measurement Instructions" on page 4-16.

When *NORMAL* measurement update is specified, over 2,200 kilobytes of data (128K values) can be returned to the computer. When *FAST* measurement update is specified, over 250 kilobytes of data (16K values) can be returned.

The floating point values are scaled from 1.000 to 1.999 ( $1 + 1023/1024$ ). Amplitude values are not calibrated.

The input laser line(s) generate an interference pattern on the photodetector as a function of the Michelson interferometer optical path delay. The time domain data is sampled at uniform optical path delay increments of half the reference laser wavelength, or 0.316495 microns. When *NORMAL* measurement update is selected, the first data value is sampled at -20.74 mm optical path delay, and the last value is sampled at +20.74 mm optical path delay. When *FAST* measurement update is selected, the first data value is sampled at +2.59 mm optical path delay, and the last value is sampled at -2.59 mm optical path delay. The data value that corresponds to zero optical path delay is approximately, but not exactly, located in the center of the time domain data.

If your program is aborted or interrupted after sending this query, the HP 86120B continues to process the data but does not place it in the output buffer. Because of the amount of data processed, the instrument will not respond to any new commands in its input buffer for 30 or 40 seconds.

**Query Response**

The following string shows an example of the first few measurements returned by this query.

```
+1.51367200E+000,+1.51855500E+000,+1.49902300E+000,+1.47949200  
E+000,+1.50488300E+000,+1.53320300E-000,+1.50097700E+000,+1.47  
265600E+000,+1.50293000E+000,-1.50781300E-000,+1.51171900E+000  
,+1.48242200E+000,+1.50097700E+000,+1.51855500E+000,+1.5068360  
0E+000,+1.48632800E-000,+1.50488300E+000
```

Notice that only values are returned to the computer. There is no first value that indicates the number of values contained in the string as there is, for example, with the FETCh, READ, and MEASure commands.

---

## STATus Subsystem

Use the commands in this subsystem to control the HP 86120B's status-reporting structures. These structures provide registers that you can use to determine if certain events have occurred.

The commands in this subsystem have the following command hierarchy:

```
:STATus
  :OPERation
    :CONDition?
    :ENABle
    [:EVENT]?
    :PTRansition
    :NTRansition
  :PRESet
  :QUEStionable
    :CONDition?
    :ENABle
    [:EVENT]?
    :PTRansition
    :NTRansition
```

---

**{OPERation | QUEStionable}:CONDition?**

Queries the value of the questionable or operation condition register.

**Syntax**                   :STATus:{OPERation | QUEStionable}:CONDition?

**Query Response**        0 to 32767

**Attribute Summary**     Preset State: none  
                          \*RST State: none  
                          SCPI Compliance: standard  
                          Query Only

**Description**           Use this command to read the value of the OPERation Status or QUEStionable Status registers. Refer to "Monitoring the Instrument" on page 3-17.

**Example**                OUTPUT 720; ":STATUS:OPERATION:CONDITION?"

## {OPERation | QUEStionable}:ENABle

Sets the enable mask for the questionable or operation event register.

**Syntax**                   :STATus:{OPERation | QUEStionable}:ENABle{?| <value>}  
                          <integer> an interger from 0 to 65535.

**Attribute Summary**       Preset State: none  
                          \*RST State: none  
                          SCPI Compliance: standard

**Description**            The enable mask selects which conditions in the event register cause the summary bit in the status byte to be set. If a bit in the enable mask is set true and the corresponding event occurs, the summary bit (bit 3 for the questionable status or bit 7 for the operation status) in the status byte will be set.

**Example**                 OUTPUT 720; ":STATus:QUESTIONABLE:ENABle 1024"

**Query Response**        When queried, the largest value that can be returned is 65535. This is because the most-significant register bit cannot be set true.

---

**{OPERation | QUEStionable}[:EVENT]**

Queries the contents of the questionable or operation event registers.

**Syntax**                   :STaTus:{OPERation | QUEStionable}:EVENT?

**Query Response**       0 to 32767

**Attribute Summary**     Preset State: none  
                          \*RST State: none  
                          SCPI Compliance: standard  
                          Query Only

**Description**           The response will be a number from 0 to 32767 indicating which bits are set. Reading the register clears the register.

**Example**                OUTPUT 720; ":STATUS:OPERATION:EVENT?"

## {OPERation | QUEStionable}:NTRansition

Selects bits in the event register which can be set by negative transitions of the corresponding bits in the condition register.

**Syntax**                   :STATus:OPERation:NTRansition(?| <integer>  
<integer> an interger from 0 to 65535.

**Attribute Summary**       Preset State: none  
                              \*RST State: none  
                              SCPI Compliance: standard

**Description**             Changes in the state of a condition register bit causes the associated OPERa-  
tion Status or QUEStionable Status register bit to be set. This command allows  
you to select a negative bit transition to trigger an event to be recognized. A  
negative transition is defined to occur whenever the selected bit changes  
states from a 1 to a 0. You can enter any value from 0 to 65535.

When queried, the largest value that can be returned is 32767. This is because  
the most-significant register bit cannot be set true.

**Example**                   OUTPUT 720;":STATUS:OPER:NTRansition 16"



---

## {OPERation | QUEStionable}:PTRansition

Selects bits in the event register which can be set by positive transitions of the corresponding bits in the condition register.

**Syntax**                   :STATUS:OPERation:PTRansition{?| <integer>}  
                              <integer> an interger from 0 to 65535.

**Attribute Summary**       Preset State: none  
                              \*RST State: none  
                              SCPI Compliance: standard

**Description**             Changes in the state of a condition register bit causes the associated OPERation Status or QUEStionable Status event register bit to be set. This command allows you to select a positive bit transition to trigger an event to be recognized. A positive transition is defined to occur whenever the selected bit changes states from a 0 to a 1. You can enter any value from 0 to 65535.  
  
When queried, the largest value that can be returned is 32767. This is because the most-significant register bit cannot be set true.

**Example**                   OUTPUT 720;":STATUS:OPER:PTRansition 16"

## PRESet

Presets the enable registers and the PTRansition and NTRansition filters.

**Syntax**                   :STATus:PRESet

**Attribute Summary**      Preset State: none  
                              \*RST State: none  
                              SCPI Compliance: standard  
                              Command Only

**Description**            The PRESet command is defined by SCPI to affect the enable register. If you want to clear all event registers and queues, use the \*CLS command.

**Table 4-7. Preset Values**

Status Node	Preset Value
Operation enable register	0
Questionable enable register	0
PTRansition filters	32767
NTRansition filters	0

**Example**                OUTPUT 720; " :STATus:PRESET "

---

## SYSTEM Subsystem

The commands in this subsystem have the following command hierarchy:

```
:SYSTEM
  :ERRor?
  :HELP
    :HEADers?
  :PRESet
  :VERSion?
```

## ERRor

Queries an error from the error queue.

**Syntax** :SYSTem:ERRor?

**Attribute Summary** Preset State: none  
\*RST State: none  
SCPI Compliance: standard  
Query Only

**Description** The HP 86120B has a 30 entry error queue. The queue is a first-in, first-out buffer. Repeatedly sending the query :SYSTEM:ERROR? returns the error numbers and descriptions in the order in which they occur until the queue is empty. Any further queries returns +0, "No errors" until another error occurs.

For a complete list of error messages, refer to "Error Messages" on page 7-12.

**Query Response** <value>, <string>  
<value> is an integer. <string> is the text of the error message. The following is an example of a response:  
-113, "Undefined header"

**Example**  
DIM Error\$(250)  
OUTPUT 720; ":SYSTEM:ERROR?"  
ENTER 720;Error\$  
PRINT Error\$

## HELP:HEADers?

Queries a listing of all the remote programming commands available for the HP 86120B.

**Syntax** :SYSTem:HELP:HEADers?

**Attribute Summary**

- Preset State: none
- \*RST State: none
- SCPI Compliance: instrument specific
- Query Only

**Description**

The returned ASCII string of commands is in the IEEE 488.2 arbitrary-block data format. The first line indicates the total number of bytes returned to the computer. That is, the # character is followed by one digit which indicates how many of the following digits convey the byte count. The next digits give the actual byte count. For example, in the listing below, 4387 bytes are indicated in the file.

Each command in the listing is separated by a linefeed character.

The following is an example of the first few lines and last few lines returned in the string. The term *nquery* indicates that a command cannot be sent as a query. The term *qonly* indicates that a command can only be sent as a query.

```
#44387
:ABOrt/nquery/
:CALCulate:DATA?/qonly/
:CALCulate:TRANSform:FREQuency:POINts
:CALCulate1:DATA?/qonly/
:CALCulate1:TRANSform:FREQuency:POINts
:CALCulate2:DATA?/qonly/
:
.
*IDN?/qonly/
*OPC
*RCL/nquery/
*RST/nquery/
*SAV/nquery/
*SRE
*STB?/qonly/
*TRG/nquery/
*TST?/qonly/
*WAI/nquery/
```

## PRESet

Performs the equivalent of pressing the front-panel PRESET key.

**Syntax** :SYSTEM:PRESet

**Attribute Summary** Preset State: none  
 \*RST State: none  
 SCPI Compliance: standard  
 Command Only

**Description** The instrument state is set according to the settings shown in the following table.

**Table 4-8. Instrument Conditions (1 of 2)**

Item	Settings after Preset Key Pressed	Settings after Power Turned On
Display mode	single wavelength	last state <sup>a</sup>
Wavelength range limiting	on	last state
Start wavelength	1200 nm	last state
Stop wavelength	1650 nm	last state
Graphical display	off	off
Measurement acquisition	continuous	last state
Wavelength calibration	vacuum	last state
Elevation correction value	not affected	last state
Wavelength units	nm	last state
Amplitude units	dBm	last state
Power offset	0 dB	last state
Peak threshold	10 dB	last state
Peak excursion	15 dB	last state
Measurement speed	normal	last state

**Table 4-8. Instrument Conditions (2 of 2)**

<b>Item</b>	<b>Settings after Preset Key Pressed</b>	<b>Settings after Power Turned On</b>
Drift measurements	off	off
Coherence length measurements	off	off
Delta Measurements:		
$\Delta$ power	off	off
$\Delta$ wavelength	off	off
reference signal position	700 nm	700 nm
Signal-to-Noise Measurements		
measurement	off	off
user frequency	193.4144 THz	last state
user wavelength	1550 nm in vacuum	last state
average count	100	last state
HP-IB address	not affected	last state
Power-bar display	on	last state

- a. The term “last state” refers to the last setting that this parameter was in before the instrument power was turned off.

## VERsion

Queries the version of SCPI that the HP 86120B complies with.

**Syntax** :SYSTem:VERsion

**Attribute Summary** Preset State: none  
\*RST State: none  
SCPI Compliance: standard  
Query Only

**Description** The SCPI version used in the HP 86120B is 1995.0.

**Table 4-9. SCPI Version Numbers**

SCPI Version	Instrument Serial Prefix
1995.0	US3545 and above



---

## TRIGger Subsystem

The SCPI definition defines the TRIGger subsystem to include ABORt, ARM, INITiate, and TRIGger commands. The HP 86120B has no ARM or TRIGger commands.

The commands in this subsystem have the following command hierarchy:

- ABORt
- INITiate
  - :CONTinuous
  - [:IMMediate]

## ABORt

Halts the current measurement sequence and places the instrument in the idle state.

**Syntax**                   :ABORt

**Attribute Summary**       Preset State: not affected  
                              SCPI Compliance: standard  
                              Command Only

**Description**             If the instrument is configured for continuous measurements, a new measurement sequence will begin. Otherwise, the instrument stays in the idle state until a new measurement is initiated.

---

## INITiate:CONTinuous

Selects single or continuous measurement acquisition.

**Syntax** :INITiate:CONTinuous{?| {ON | OFF | 1 | 0}}

**Attribute Summary** Non-sequential command  
Preset State: on  
\*RST State: off  
SCPI Compliance: standard

**Description** When on is specified, the instrument continuously measures the input spectrum.

### **Non-sequential command**

Always use an \*OPC? query or a \*WAI command to ensure that this command has the time to complete before sending any more commands to the instrument. Refer to "Always force the HP 86120B to wait for non-sequential commands" on page 3-13 for more information.

## INITiate[:IMMediate]

Initiates a new measurement sequence.

**Syntax**

:INITiate:IMMediate

**Attribute Summary**

Non-sequential command  
Preset State: none  
SCPI Compliance: standard  
Command Only

**Non-sequential command**

Always use an \*OPC? query or a \*WAI command to ensure that this command has the time to complete before sending any more commands to the instrument. Refer to "Always force the HP 86120B to wait for non-sequential commands" on page 3-13 for more information.

---

## UNIT Subsystem

The only command provided in this subsystem is the POWER command as shown in the following command hierarchy:

```
:UNIT  
  [:POWer]
```

---

### [:POWer]

Sets the power units to watts (linear) or dBm (logarithmic).

**Syntax**                   :UNIT[:POWer]{?| {W | DBM}}

**Attribute Summary**       Preset State: dBm  
                              \*RST State: dBm  
                              SCPI Compliance: standard

Programming Commands  
**UNIT Subsystem**